

## 8-Channel DAS with 16-Bit, 1 MSPS Bipolar Input, Simultaneous Sampling ADC

### FEATURES

- ▶ 16-bit ADC with 1 MSPS on all channels
- ▶ Input buffer with 1 MΩ minimum analog input impedance ( $R_{IN}$ )
- ▶ Single 5 V analog supply and 1.71 V to 5.25 V  $V_{DRIVE}$  supply
- ▶ Per channel selectable analog input ranges
  - ▶ Bipolar single-ended:  $\pm 12.5$  V,  $\pm 10$  V,  $\pm 6.25$  V,  $\pm 5$  V,  $\pm 2.5$  V
  - ▶ Unipolar single-ended: 0 V to 12.5 V, 0 V to 10 V, 0 V to 5 V
  - ▶ Bipolar differential:  $\pm 20$  V,  $\pm 12.5$  V,  $\pm 10$  V,  $\pm 5$  V
- ▶ Two bandwidth options: 25 kHz and 220 kHz, per channel
- ▶ Flexible digital filter, oversampling ratio up to 256
- ▶  $-40^{\circ}\text{C}$  to  $+125^{\circ}\text{C}$  operating temperature range
- ▶  $\pm 21$  V input clamp protection with 6 kV ESD
- ▶ Pin to pin compatible to the [AD7606](#) and [AD7606B](#)
- ▶ Performance
  - ▶ 92 dB typical SNR for  $\pm 20$  V bipolar differential range
  - ▶ 95 dB SNR, oversampling by 32
  - ▶  $-100$  dB typical THD for all other ranges
  - ▶ TUE = 0.05% of FSR maximum, external reference
  - ▶  $\pm 0.5$  ppm/ $^{\circ}\text{C}$  typical PFS and NFS error drift
  - ▶  $\pm 3$  ppm/ $^{\circ}\text{C}$  typical reference temperature coefficient

### CALIBRATION AND DIAGNOSTICS

- ▶ Per channel system phase, offset, and gain calibration
- ▶ Analog input open circuit detection feature
- ▶ Self diagnostics and monitoring features
- ▶ CRC error checking on read/write data and registers

### APPLICATIONS

- ▶ Power line monitoring
- ▶ Protective relays
- ▶ Multiphase motor control
- ▶ Instrumentation and control systems
- ▶ Data acquisition systems

### COMPANION PRODUCTS

- ▶ Voltage references: [ADR4525](#), [LT6657](#), [LTC6655](#)
- ▶ Digital isolators: [ADuM142E](#), [ADuM6422A](#), [ADuM5020](#), [ADuM5028](#)
- ▶ [AD7606x family software model](#)
- ▶ Additional companion products on the [AD7606C-16 product page](#).

### FUNCTIONAL BLOCK DIAGRAM

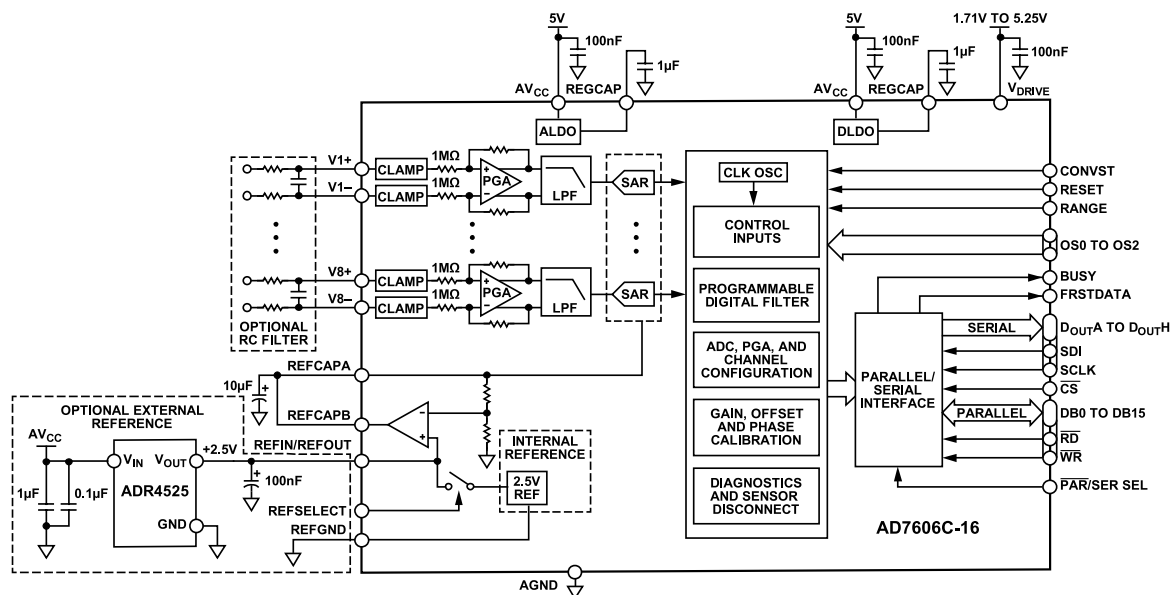

Figure 1. Functional Block Diagram

Rev. A

DOCUMENT FEEDBACK

TECHNICAL SUPPORT

Information furnished by Analog Devices is believed to be accurate and reliable "as is". However, no responsibility is assumed by Analog Devices for its use, nor for any infringements of patents or other rights of third parties that may result from its use. Specifications subject to change without notice. No license is granted by implication or otherwise under any patent or patent rights of Analog Devices. Trademarks and registered trademarks are the property of their respective owners. All Analog Devices products contained herein are subject to release and availability.

**TABLE OF CONTENTS**

Features.....	1	External Oversampling Clock.....	39
Calibration and Diagnostics.....	1	System Calibration Features.....	40
Applications.....	1	System Phase Calibration.....	40
Companion Products .....	1	System Gain Calibration.....	40
Functional Block Diagram.....	1	System Offset Calibration.....	41
General Description.....	5	Analog Input Open Circuit Detection.....	41
Specifications.....	6	Digital Interface.....	43
Timing Specifications.....	9	Hardware Mode.....	43
Absolute Maximum Ratings.....	14	Software Mode.....	43
Thermal Resistance.....	14	Parallel Interface.....	44
Electrostatic Discharge (ESD) Ratings.....	14	Serial Interface.....	47
ESD Caution.....	14	Diagnostics.....	52
Pin Configuration and Function Descriptions.....	15	Reset Detection.....	52
Typical Performance Characteristics.....	18	Digital Error .....	52
Terminology.....	29	Diagnostics Multiplexer.....	55
Theory of Operation.....	31	Typical Connection Diagram.....	58
Analog Front End.....	31	Layout Guidelines.....	60
SAR ADC.....	32	Register Summary.....	61
Reference.....	35	Register Details.....	63
Operation Modes.....	35	Outline Dimensions.....	80
Digital Filter.....	38	Ordering Guide.....	80
Padding Oversampling.....	39	Evaluation Boards.....	80

**REVISION HISTORY****8/2025—Rev. 0 to Rev. A**

Reorganized Layout (Universal).....	1
Changes to Features Section.....	1
Changes to Figure 1.....	1
Changes to Specifications Section and Table 2.....	6
Changes to Table 3 and Figure 2.....	9
Deleted Universal Timing Diagram Section.....	10
Changes to Table 4, and Figure 3 Caption to Figure 5 Caption.....	11
Deleted Parallel Mode Timing Diagrams Section.....	11
Changes to Table 5, Figure 6 Caption, and Figure 7 Caption.....	12
Deleted Serial Mode Timing Diagrams Section.....	13
Changes to Table 6.....	14
Changes to Table 8.....	14
Changes to Table 9.....	15
Change to Figure 9 Caption.....	18
Added Figure 74; Renumbered Sequentially.....	28
Changes to Full-Scale (FS) Error Section.....	29
Changes to Channel-to-Channel Isolation Section.....	30
Changes to Analog Input Ranges Section.....	31
Changes to ADC Transfer Function Section, Table 11, and Table 12.....	33
Changes to Reference Section and Figure 84.....	35
Changes to Table 15.....	36
Changes to Reset Functionality Section.....	36
Changes to Power-Down Modes Section and Figure 87.....	36

## TABLE OF CONTENTS

Changes to Digital Filter Section.....	38
Changes to System Phase Calibration Section and Figure 92.....	40
Changes to System Gain Calibration Section.....	40
Changes to System Offset Calibration Section and Table 20.....	41
Changes to Analog Input Open Circuit Detection Section.....	41
Changes to Manual Mode Section and Figure 97.....	41
Changes to Automatic Mode Section and Figure 98.....	41
Changes to Hardware Mode Section.....	43
Change to Software Mode Section.....	43
Changes to Parallel Interface Section.....	44
Changed Reading Conversion Results (Parallel ADC Mode) Section to Reading Conversion Results (Parallel ADC Read Mode) Section.....	44
Changes to Reading During Conversion Section.....	45
Changed Parallel ADC Mode with CRC Enabled Section to Parallel ADC Read Mode with CRC Enabled Section.....	45
Changed Parallel ADC Mode with Status Enabled Section to Parallel ADC Read Mode with Status Enabled Section.....	45
Changes to Parallel ADC Read Mode with Status Enabled Section, Table 24 Title, Table 25, and Figure 102 Caption.....	45
Changes to Parallel Register Mode (Reading Register Data) Section.....	46
Changes to Parallel Register Mode (Writing Register Data) Section and Figure 103.....	46
Change to Figure 104.....	47
Changed Reading Conversion Results (Serial ADC Mode) Section to Reading Conversion Results (Serial ADC Read Mode) Section.....	47
Changes to Reading Conversion Results (Serial ADC Read Mode) Section.....	47
Changes to Figure 109 and Figure 110 Caption.....	48
Changed Reading During Conversion Section to Reading During Conversion—Serial Interface Section....	48
Changes to Reading During Conversion—Serial Interface Section.....	48
Changed Serial ADC Mode with CRC Enabled Section to Serial ADC Read Mode with CRC Enabled Section.....	48
Changed Serial ADC Mode with Status Enabled Section to Serial ADC Read Mode with Status Enabled Section.....	49
Changes to Serial ADC Read Mode with Status Enabled Section.....	49
Changes to Serial Register Mode (Reading Register Data) Section, Figure 111, and Table 27.....	49
Changes to Serial Register Mode (Writing Register Data) Section.....	50
Changes to Figure 114 and Figure 115.....	51
Changes to Diagnostics Section.....	52
Changes to Digital Error Section.....	52
Change to ROM CRC Section.....	52
Changes to Memory Map CRC Section.....	52
Changes to Interface CRC Checksum Section.....	52
Changes to Table 29.....	54
Deleted Figure 118; Renumbered Sequentially.....	54
Added Internal Clock Counters Section.....	55
Changes to Diagnostics Multiplexer Section and Table 30.....	55
Changes to Temperature Sensor Section.....	55
Added Figure 120 and Figure 121.....	55
Changes to Internal LDOs Section.....	57
Changes to Supply Voltages Section.....	57

**TABLE OF CONTENTS**

Deleted Applications Information Section.....	60
Changes to Layout Guidelines Section.....	60
Change to Table 31.....	61
Changes to Register Details Section and Table 32 to Table 37.....	63
Changes to Table 39 to Table 48.....	68
Changes to Table 56 to Table 65.....	72
Changes to Table 67 to Table 71.....	75
Changes to Table 75.....	79
Changes to Evaluation Boards.....	80

**1/2021—Revision 0: Initial Version**

## GENERAL DESCRIPTION

The AD7606C-16 is a 16-bit, simultaneous sampling, analog-to-digital data acquisition system (DAS) with eight channels. Each channel contains analog input clamp protection, a programmable gain amplifier (PGA), a low-pass filter (LPF), and a 16-bit successive approximation register (SAR), analog-to-digital converter (ADC). The AD7606C-16 also contains a flexible digital filter, a low drift, 2.5 V precision reference, and a reference buffer to drive the ADC and flexible parallel and serial interfaces.

The AD7606C-16 operates from a single 5 V supply and accommodates the following input ranges when sampling at throughput rates of 1 MSPS for all channels:

- ▶ Bipolar single-ended:  $\pm 12.5$  V,  $\pm 10$  V,  $\pm 6.25$  V,  $\pm 5$  V, and  $\pm 2.5$  V
- ▶ Unipolar single-ended: 0 V to 12.5 V, 0 V to 10 V, and 0 V to 5 V
- ▶ Bipolar differential:  $\pm 20$  V,  $\pm 12.5$  V,  $\pm 10$  V, and  $\pm 5$  V

The input clamp protection tolerates voltages up to  $\pm 21$  V. The single supply operation, on-chip filtering, and high input impedance eliminate the need for external driver op amps, which require bipolar supplies. For applications with lower throughput rates, the AD7606C-16 flexible digital filter can be used to improve noise performance.

In hardware mode, the AD7606C-16 is fully compatible with the [AD7606](#) and [AD7606B](#). In software mode, the following advanced features are available:

- ▶ Analog input range selectable per channel with added ranges available
- ▶ High bandwidth mode (220 kHz) selectable per channel
- ▶ Additional oversampling options with an oversampling ratio up to 256
- ▶ System gain, system offset, and system phase calibration per channel
- ▶ Analog input open circuit detector
- ▶ Diagnostic multiplexer
- ▶ Monitoring functions (serial peripheral interface (SPI), invalid read/write, cyclic redundancy check (CRC), busy stuck monitor, and reset detection)

Note that throughout this data sheet, multifunction pins, such as the  $\overline{RD}/SCLK$  pin, are referred to either by the entire pin name or by a single function of the pin, for example, the SCLK pin, when only that function is relevant.

**Table 1. Bipolar Input, Simultaneous Sampling, Pin-to-Pin Compatible Family of Devices**

Input Type	Resolution (Bits)	$R_{IN}^1 = 1 \text{ M}\Omega$ , 200 kSPS	$R_{IN} = 5 \text{ M}\Omega$ , 800 kSPS	$R_{IN} = 1 \text{ M}\Omega$ , 1 MSPS	Number of Channels
Single-Ended	18	<a href="#">AD7608</a>	AD7606B <sup>2</sup>	<a href="#">AD7606C-18</a> <sup>2</sup>	8
	16	<a href="#">AD7606</a>		<a href="#">AD7606C-16</a> <sup>2</sup>	8
		<a href="#">AD7606-6</a>			6
		<a href="#">AD7606-4</a>			4
	14	<a href="#">AD7607</a>			8
True Differential	18	<a href="#">AD7609</a>		<a href="#">AD7606C-18</a> <sup>2</sup>	8
	16			<a href="#">AD7606C-16</a> <sup>2</sup>	8

<sup>1</sup>  $R_{IN}$  is input impedance.

<sup>2</sup> This state-of-the-art device is recommended for newer designs as an alternative to the AD7606, AD7608, and AD7609.

## SPECIFICATIONS

Voltage reference ( $V_{REF}$ ) = 2.5 V external and internal, analog supply voltage ( $AV_{CC}$ ) = 4.75 V to 5.25 V, logic supply voltage ( $V_{DRIVE}$ ) = 1.71 V to 5.25 V, sample frequency ( $f_{SAMPLE}$ ) = 1 MSPS, with no OS,  $T_A$  =  $-40^{\circ}\text{C}$  to  $+125^{\circ}\text{C}$ , and all input voltage ranges, unless otherwise noted.

Table 2. Specifications

Parameter	Test Conditions/Comments	Min	Typ	Max	Unit	
<b>DYNAMIC PERFORMANCE</b>						
	Input frequency ( $f_{IN}$ ) = 1 kHz sine wave, unless otherwise noted					
Signal-to-Noise Ratio (SNR) Low Bandwidth Mode	$\pm 20$ V bipolar differential range	90	92		dB	
	$\pm 20$ V bipolar differential range, oversampling by 32, $f_{IN} = 50$ Hz		95		dB	
	$\pm 12.5$ V bipolar differential range	89	90		dB	
	$\pm 10$ V bipolar differential range	89	90.5		dB	
	$\pm 5$ V bipolar differential range	88	90		dB	
	$\pm 12.5$ V bipolar single-ended range	88.5	90.5		dB	
	$\pm 10$ V bipolar single-ended range	89.5	91.5		dB	
	$\pm 6.25$ V bipolar single-ended range	88.5	90.5		dB	
	$\pm 5$ V bipolar single-ended range	88.5	90		dB	
	$\pm 2.5$ V bipolar single-ended range	86	88		dB	
	0 V to 12.5 V unipolar single-ended range	88	90		dB	
	0 V to 10 V unipolar single-ended range	87.5	89		dB	
	0 V to 5 V unipolar single-ended range	84	86		dB	
	High Bandwidth Mode	$\pm 20$ V bipolar differential range		88		dB
		$\pm 12.5$ V bipolar differential range		86.5		dB
		$\pm 10$ V bipolar differential range		86		dB
		$\pm 5$ V bipolar differential range		83.5		dB
		$\pm 12.5$ V bipolar single-ended range		86.5		dB
		$\pm 10$ V bipolar single-ended range		86		dB
		$\pm 6.25$ V bipolar single-ended range		83.5		dB
$\pm 5$ V bipolar single-ended range			82.5		dB	
$\pm 2.5$ V bipolar single-ended range			81		dB	
0 V to 12.5 V unipolar single-ended range			82		dB	
0 V to 10 V unipolar single-ended range		81		dB		
0 V to 5 V unipolar single-ended range		80		dB		
Total Harmonic Distortion (THD)	Low bandwidth mode					
	Unipolar input ranges		-97		dB	
	All other ranges		-100	-95	dB	
Spurious-Free Dynamic Range (SFDR)			-105		dB	
Channel-to-Channel Isolation	$f_{IN}$ on unselected channels up to 200 kHz		-110		dB	
Full-Scale Step Settling Time	0.01% of FS, low bandwidth mode		80		$\mu\text{s}$	
	0.01% of FS, high bandwidth mode		15		$\mu\text{s}$	
<b>ANALOG INPUT FILTER</b>						
-3 dB Full Power Bandwidth	Low bandwidth mode		25		kHz	
	High bandwidth mode		220		kHz	
	High bandwidth mode, 2.5 V bipolar, 0 V to 5 V unipolar		150		kHz	
-0.1 dB Full Power Bandwidth	Low bandwidth mode		3.9		kHz	
	High bandwidth mode		25		kHz	
	High bandwidth mode, 2.5 V bipolar, 0 V to 5 V unipolar		20		kHz	
Phase Delay	Low bandwidth mode		6.7		$\mu\text{s}$	
	High bandwidth mode		1.1		$\mu\text{s}$	
	High bandwidth mode, 2.5 V range, 0 V to 5 V unipolar		1.7		$\mu\text{s}$	

## SPECIFICATIONS

Table 2. Specifications (Continued)

Parameter	Test Conditions/Comments	Min	Typ	Max	Unit
Phase Delay Matching	Low bandwidth mode			200	ns
	High bandwidth mode			30	ns
<b>DC ACCURACY</b>					
Resolution	No missing codes	16			Bits
Differential Nonlinearity (DNL)			±0.5	±0.99	LSB <sup>1</sup>
Integral Nonlinearity (INL)	Bipolar input ranges		±0.5	±2	LSB <sup>1</sup>
	Unipolar input ranges		±1		LSB
Total Unadjusted Error (TUE) <sup>2</sup>	External reference, bipolar input ranges		±6	±30	LSB
	External reference, ±2.5 V range		±6	±45	LSB
	Unipolar input ranges		±15	±70	LSB
<b>Bipolar Ranges</b>					
Positive and Negative Full-Scale (FS) Error <sup>3</sup>			±5	±30	LSB
Positive and Negative FS Error Drift			±0.5	±3	ppm/°C
Positive and Negative FS Error Matching			4	20	LSB
Bipolar Zero Code Error	2.5 V range		±2	±40	LSB <sup>1</sup>
	All other input ranges		±2	±20	LSB <sup>1</sup>
Bipolar Zero Code Error Drift	2.5 V range		±2	±5	ppm/°C
	All other input ranges		±0.5	±2.5	ppm/°C
Bipolar Zero Code Error Matching			5	25	LSB <sup>1</sup>
<b>Unipolar Ranges</b>					
FS Error			±15	±60	LSB
FS Error Drift			±1	±7	ppm/°C
FS Error Matching			5	40	LSB
Zero Scale Error			±15	±50	LSB
Zero Scale Error Drift			±2.5	±7	ppm/°C
Zero Scale Error Matching			5	40	LSB
<b>SYSTEM CALIBRATION</b>					
Positive Full-Scale (PFS) and Negative Full-Scale (NFS) Calibration Range	Series resistor in front of the V <sub>x+</sub> and V <sub>x-</sub> inputs	1		64	kΩ
Offset Calibration Range		-128		+127	LSB
Phase Calibration Range		1		255	μs
PFS and NFS Error	After gain calibration		±15		LSB
Offset Error	After offset calibration		±0.5		LSB
Phase Error	After phase calibration		±1		μs
<b>ANALOG INPUT</b>					
Input Voltage (V <sub>IN</sub> ) Ranges	V <sub>IN</sub> = V <sub>x+</sub> - V <sub>x-</sub>				
	±20 V bipolar differential range	-20		+20	V
	±12.5 V bipolar differential range	-12.5		+12.5	V
	±10 V bipolar differential range	-10		+10	V
	±5 V bipolar differential range	-5		+5	V
	±12.5 V bipolar single-ended range	-12.5		+12.5	V
	±10 V bipolar single-ended range	-10		+10	V
	±6.25 V bipolar single-ended range	-6.25		+6.25	V
±5 V bipolar single-ended range	-5		+5	V	

## SPECIFICATIONS

Table 2. Specifications (Continued)

Parameter	Test Conditions/Comments	Min	Typ	Max	Unit
Absolute Voltage Negative Input	±2.5 V bipolar single-ended range	-2.5		+2.5	V
	0 V to 12.5 V unipolar single-ended range	0		12.5	V
	0 V to 10 V unipolar single-ended range	0		10	V
	0 V to 5 V unipolar single-ended range	0		5	V
	V <sub>X-</sub> – AGND				
	±12.5 V bipolar single-ended range	-1		+1.6	V
	±10 V bipolar single-ended range	-0.6		+1.9	V
	±6.25 V bipolar single-ended range	-0.4		+2.5	V
	±5 V bipolar single-ended range	-0.1		+2.7	V
	±2.5 V bipolar single-ended range	-0.05		+3	V
Common-Mode Input Range	0 V to 12.5 V unipolar single-ended range	-6.5		+1.2	V
	0 V to 10 V unipolar single-ended range	-4.9		+1.7	V
	0 V to 5 V unipolar single-ended range	-2.3		+4	V
	±20 V bipolar differential range	-10		+10	V
	±12.5 V bipolar differential range	-7.8		+7.8	V
	±10 V bipolar differential range	-6		+7	V
	±5 V bipolar differential range	-3		+5	V
	Analog Input Current			(V <sub>IN</sub> - 2)/R <sub>IN</sub>	μA
	Input Impedance (R <sub>IN</sub> ) <sup>4</sup>		1	1.2	MΩ
	Input Capacitance (C <sub>IN</sub> ) <sup>5</sup>			5	pF
Input Impedance Drift			±1	±25	ppm/°C
REFERENCE INPUT AND OUTPUT					
Reference Input Voltage	External reference	2.495	2.5	2.505	V
DC Leakage Current				±0.12	μA
Input Capacitance (C <sub>IN</sub> )			7.5		pF
Reference Output Voltage	Internal reference, T <sub>A</sub> = 25°C	2.4975	2.5	2.5025	V
Reference Temperature Coefficient			±3	±10	ppm/°C
Reference Voltage to the ADC	REFCAPA (Pin 44) and REFCAPB (Pin 45)	4.39		4.41	V
LOGIC INPUTS					
Input High Voltage (V <sub>INH</sub> )		0.7 × V <sub>DRIVE</sub>			V
Input Low Voltage (V <sub>INL</sub> )				0.2 × V <sub>DRIVE</sub>	V
Input Current (I <sub>IN</sub> )				±1	μA
Input Capacitance (C <sub>IN</sub> )			5		pF
LOGIC OUTPUTS					
Output High Voltage (V <sub>OH</sub> )	Current source (I <sub>SOURCE</sub> ) = 100 μA	V <sub>DRIVE</sub> - 0.2			V
Output Low Voltage (V <sub>OL</sub> )	Current sink (I <sub>SINK</sub> ) = 100 μA			0.2	V
Floating State Leakage Current				±1	μA
Output Capacitance (C <sub>OUT</sub> ) <sup>5</sup>			5		pF
Output Coding Bipolar Ranges	Twos complement				
Output Coding Unipolar Ranges	Straight binary				
CONVERSION RATE					
Conversion Time	See Table 3		550		ns
Acquisition Time (t <sub>ACQ</sub> ) <sup>6</sup>			450		ns
Throughput Rate	Per channel			1000	kSPS
POWER REQUIREMENTS					
V <sub>CC</sub>		4.75	5	5.25	V
V <sub>DRIVE</sub>		1.71		5.25	V
V <sub>CC</sub> Current (I <sub>AVCC</sub> )					



## SPECIFICATIONS

Table 2. Specifications (Continued)

Parameter	Test Conditions/Comments	Min	Typ	Max	Unit
Normal Mode (Static)			9	11	mA
Normal Mode (Operational)	$f_{\text{SAMPLE}} = 1 \text{ MSPS}$		45	50	mA
	$f_{\text{SAMPLE}} = 10 \text{ KSPS}$		8.5	10	mA
Standby			5	6	mA
Shutdown Mode			0.5	5	$\mu\text{A}$
$V_{\text{DRIVE}}$ Current ( $I_{\text{DRIVE}}$ )					
Normal Mode (Static)			2.8	5	$\mu\text{A}$
Normal Mode (Operational)	$f_{\text{SAMPLE}} = 1 \text{ MSPS}$		1.8	1.9	mA
	$f_{\text{SAMPLE}} = 10 \text{ KSPS}$		21	24	$\mu\text{A}$
Standby			2.5	4	$\mu\text{A}$
Shutdown Mode			0.5	1.5	$\mu\text{A}$
Power Dissipation					
Normal Mode (Static)			47	58	mW
Normal Mode (Operational)	$f_{\text{SAMPLE}} = 1 \text{ MSPS}$		245	272	mW
	$f_{\text{SAMPLE}} = 10 \text{ KSPS}$		45	52	mW
Standby			26	32	mW
Shutdown Mode			5	24	$\mu\text{W}$

<sup>1</sup> LSB means least significant bit. With a  $\pm 2.5 \text{ V}$  input range, 1 LSB = 76.293  $\mu\text{V}$ . With a  $\pm 5 \text{ V}$  input range, 1 LSB = 152.58  $\mu\text{V}$ . With a  $\pm 10 \text{ V}$  input range, 1 LSB = 305.175  $\mu\text{V}$ .

<sup>2</sup> TUE (% FSR) = TUE (LSB)/ $2^{16}$   $\times$  100. For example, 32 LSBs = 0.05 % of FSR.

<sup>3</sup> These specifications include the full temperature range variation and contribution from the reference buffer.

<sup>4</sup> Input impedance variation is factory trimmed and accounted for in the [System Gain Calibration](#) section.

<sup>5</sup> Not production tested. Sample tested during initial release to ensure compliance.

<sup>6</sup> The ADC input is settled by the internal PGA. Therefore, the  $t_{\text{ACQ}}$  is the time between the end of the conversion and the start of the next conversion with no impact on external components.

## TIMING SPECIFICATIONS

## Universal Timing Specifications

$AV_{\text{CC}} = 4.75 \text{ V}$  to  $5.25 \text{ V}$ ,  $V_{\text{DRIVE}} = 1.71 \text{ V}$  to  $5.25 \text{ V}$ ,  $V_{\text{REF}} = 2.5 \text{ V}$  external reference and internal reference, and  $T_{\text{A}} = -40^{\circ}\text{C}$  to  $+125^{\circ}\text{C}$ , unless otherwise noted. Interface timing is tested using a load capacitance of 20 pF, dependent on  $V_{\text{DRIVE}}$  and load capacitance for serial interface.

Table 3. Universal Timing Specifications

Parameter	Min	Typ	Max	Unit	Description
$t_{\text{CYCLE}}$	1			$\mu\text{s}$	Minimum time between consecutive CONVST rising edges (excluding oversampling modes) <sup>1</sup>
$t_{\text{LP\_CNV}}$	10			ns	CONVST low pulse width
$t_{\text{HP\_CNV}}$	10			ns	CONVST high pulse width
$t_{\text{D\_CNV\_BSY}}$			22	ns	CONVST high to BUSY high delay time
$t_{\text{S\_BSY}}$	0			ns	Minimum time from BUSY falling edge to $\overline{\text{RD}}$ falling edge setup time (in parallel interface) or to MSB being available on $\text{D}_{\text{OUTX}}$ line (in serial interface)
$t_{\text{D\_BSY}}$	25			ns	Minimum time between last $\overline{\text{RD}}$ falling edge (in parallel interface) or last LSB being clocked out (serial interface) and the following BUSY falling edge, read during conversion
$t_{\text{ACQ}}$	0.35			$\mu\text{s}$	Acquisition time
$t_{\text{CONV}}$	0.5		0.65	$\mu\text{s}$	Conversion time, no oversampling
	1.7		1.75	$\mu\text{s}$	Oversampling by 2
	3.6		3.8	$\mu\text{s}$	Oversampling by 4
	7.6		7.85	$\mu\text{s}$	Oversampling by 8
	15.5		16	$\mu\text{s}$	Oversampling by 16

SPECIFICATIONS

Table 3. Universal Timing Specifications (Continued)

Parameter	Min	Typ	Max	Unit	Description
$t_{SKEW}^2$	31.0		32.5	$\mu s$	Oversampling by 32
	62.75		65.0	$\mu s$	Oversampling by 64
	126		130	$\mu s$	Oversampling by 128
	252		256	$\mu s$	Oversampling by 256
$t_{RESET}$			22	ns	Skew between BUSY falling edge of different AD7606C-16 devices
Partial Reset	55		2000	ns	Partial RESET high pulse width
	3200			ns	Full RESET high pulse width
$t_{DEVICE\_SETUP}^3$				$\mu s$	Time between RESET falling edge and first CONVST rising edge
	50			ns	
Full Reset	274			$\mu s$	
$t_{WAKE\_UP}$					Wake-up time after standby/shutdown mode (see Figure 87)
	1			$\mu s$	
Standby				$\mu s$	
	10			ms	
Shutdown	10			ms	
$t_{POWER-UP}$	10			ms	Time between stable $AV_{CC}/V_{DRIVE}$ and assertion of RESET

<sup>1</sup> Applies to serial mode when all four  $D_{OUTX}$  lines are selected.

<sup>2</sup> At the same temperature, no oversampling.

<sup>3</sup> For the first RESET edge after power up, this time is longer, depending on  $t_{POWER-UP}$  time. The shorter the  $t_{POWER-UP}$  time, the longer the  $t_{DEVICE\_SETUP}$  ( $t_{POWER-UP} + t_{DEVICE\_SETUP} > 2 \text{ sec}$ ).

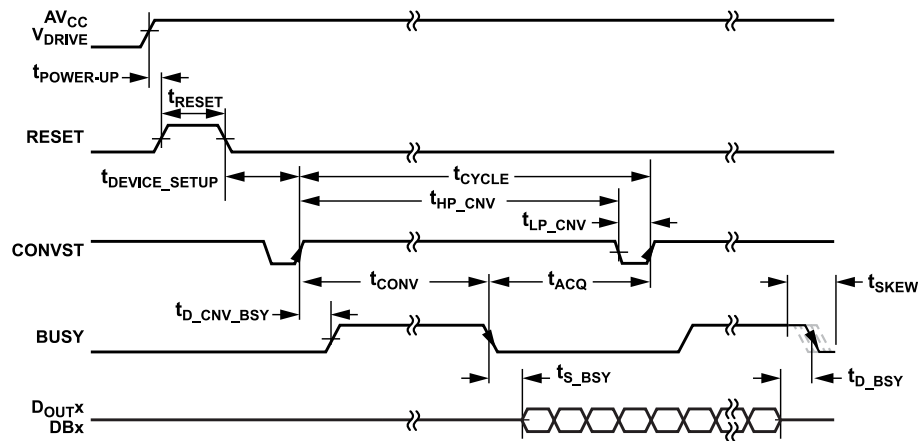

Figure 2. Universal Timing Diagram

SPECIFICATIONS

Parallel Mode Timing Specifications

Table 4. Parallel Mode Timing Specifications

Parameter	Min	Typ	Max	Unit	Description
$t_{S\_CS\_RD}$	0			ns	$\overline{CS}$ falling edge to $\overline{RD}$ falling edge setup time
$t_{H\_RD\_CS}$	0			ns	$\overline{RD}$ rising edge to $\overline{CS}$ rising edge hold time
$t_{HP\_RD}$	10			ns	$\overline{RD}$ high pulse width
$t_{LP\_RD}$	10			ns	$\overline{RD}$ low pulse width
$t_{HP\_CS}$	10			ns	$\overline{CS}$ high pulse width
$t_{D\_CS\_DB}$			35	ns	Delay from $\overline{CS}$ until DBx three-state disabled
$t_{D\_RD\_DB}$			30	ns	Data access time after falling edge of $\overline{RD}$
			25	ns	$V_{DRIVE} \geq 2.7 V$
			25	ns	$V_{DRIVE} < 2.7 V$
$t_{H\_RD\_DB}$	12			ns	Data hold time after falling edge of $\overline{RD}$
$t_{DHZ\_CS\_DB}$			40	ns	$\overline{CS}$ rising edge to DBx high impedance
$t_{CYC\_RD}$	30			ns	$\overline{RD}$ falling edge to next $\overline{RD}$ falling edge
$t_{D\_CS\_FD}$			20	ns	Delay from $\overline{CS}$ falling edge until FRSTDATA three-state disabled
$t_{D\_RD\_FDH}$			30	ns	Delay from $\overline{RD}$ falling edge until FRSTDATA high
$t_{D\_RD\_FDL}$			30	ns	Delay from $\overline{RD}$ falling edge until FRSTDATA low
$t_{DHZ\_CS\_FD}$			25	ns	Delay from $\overline{CS}$ rising edge until FRSTDATA three-state enabled
$t_{S\_CS\_WR}$	0			ns	$\overline{CS}$ to $\overline{WR}$ setup time
$t_{HP\_WR}$	2			ns	$\overline{WR}$ high pulse width
$t_{LP\_WR}$	35			ns	$\overline{WR}$ low pulse width
$t_{H\_WR\_CS}$	0			ns	$\overline{WR}$ hold time
$t_{S\_DB\_WR}$	5			ns	Configuration data to $\overline{WR}$ setup time
$t_{H\_WR\_DB}$	5			ns	Configuration data to $\overline{WR}$ hold time
$t_{CYC\_WR}$	180			ns	Configuration data settle time, $\overline{WR}$ rising edge to next $\overline{WR}$ rising edge

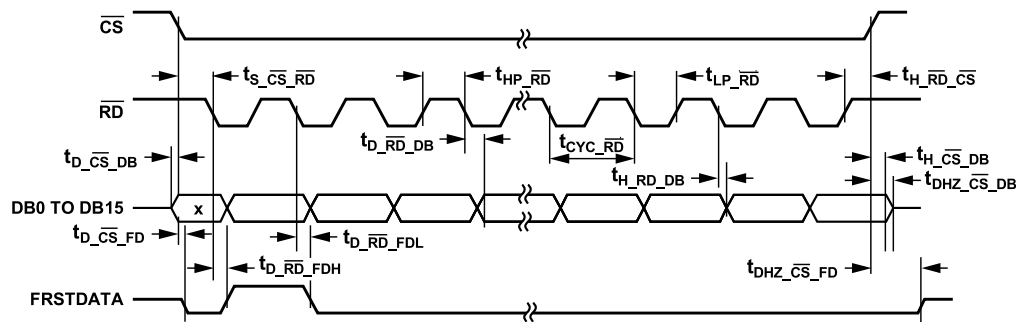

Figure 3. Parallel Mode Read Timing Diagram, Separate  $\overline{CS}$  and  $\overline{RD}$  Pulses

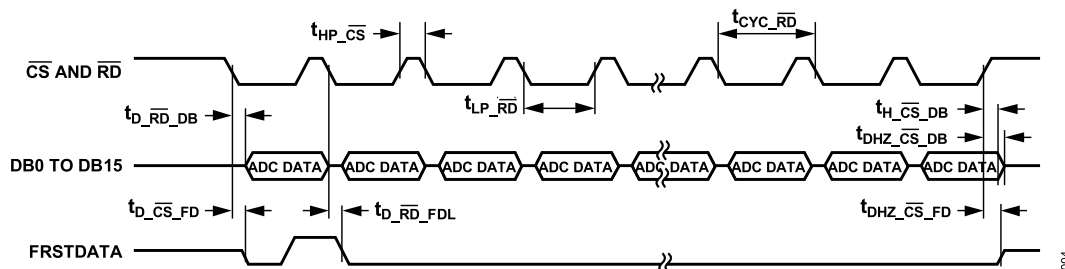

Figure 4. Parallel Mode Read Timing Diagram, Linked  $\overline{CS}$  and  $\overline{RD}$

## SPECIFICATIONS

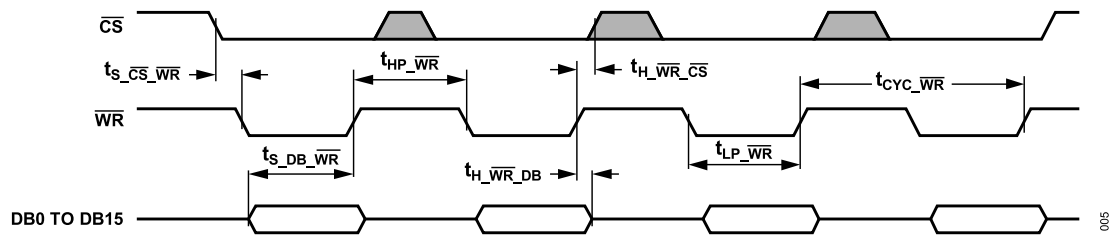

Figure 5. Parallel Mode Write Operation Timing Diagram

## Serial Mode Timing Specifications

Table 5. Serial Mode Timing Specifications

Parameter	Min	Typ	Max	Unit	Description
$f_{SCLK}$			63.5	MHz	SCLK frequency, $f_{SCLK} = 1/t_{SCLK}$ $V_{DRIVE} \geq 3.1 V$
			60	MHz	$2.7 V \leq V_{DRIVE} < 3.1 V$
			40	MHz	$V_{DRIVE} < 2.7 V$
$t_{SCLK}$	$1/f_{SCLK}$			$\mu s$	Minimum SCLK period
$t_{s\_CS\_SCK}$	2			ns	$\overline{CS}$ to SCLK falling edge setup time
$t_{H\_SCK\_CS}$	2			ns	SCLK to $\overline{CS}$ rising edge hold time
$t_{LP\_SCK}$	$0.4 \times t_{SCLK}$			ns	SCLK low pulse width
$t_{HP\_SCK}$	$0.4 \times t_{SCLK}$			ns	SCLK high pulse width
$t_{D\_CS\_DO}$			18	ns	Delay from $\overline{CS}$ until $D_{OUTX}$ three-state disabled
$t_{D\_SCK\_DO}$			15.7	ns	$V_{DRIVE} \geq 3.1 V$
			17	ns	$2.7 V \leq V_{DRIVE} < 3.1 V$
			25	ns	$V_{DRIVE} < 2.7 V$
$t_{H\_SCK\_DO}$				ns	Data out hold time after SCLK rising edge
	7			ns	$V_{DRIVE} \geq 2.7 V$
	10			ns	$V_{DRIVE} < 2.7 V$
$t_{s\_SDI\_SCK}$	9			ns	Data in setup time before SCLK falling edge
$t_{H\_SCK\_SDI}$	0			ns	Data in hold time after SCLK falling edge
$t_{DZH\_CS\_DO}$			25	ns	$\overline{CS}$ rising edge to $D_{OUTX}$ high impedance
$t_{WR}$	25			ns	Time between writing and reading the same register or between two writes, if $f_{SCLK} > 50 MHz$
$t_{D\_CS\_FD}$			16	ns	Delay from $\overline{CS}$ until $D_{OUTX}$ three-state disabled or delay from $\overline{CS}$ until MSB valid
$t_{D\_SCK\_FDL}$			18	ns	16 <sup>th</sup> SCLK falling edge to FRSTDATA low
$t_{DZH\_FD}$			20	ns	$\overline{CS}$ rising edge until FRSTDATA three-state enabled

SPECIFICATIONS

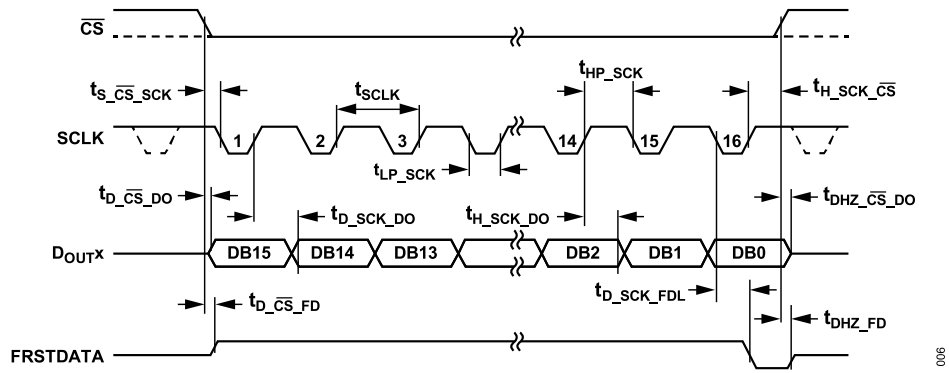

Figure 6. Serial Timing Diagram, ADC Read Mode (Channel 1)

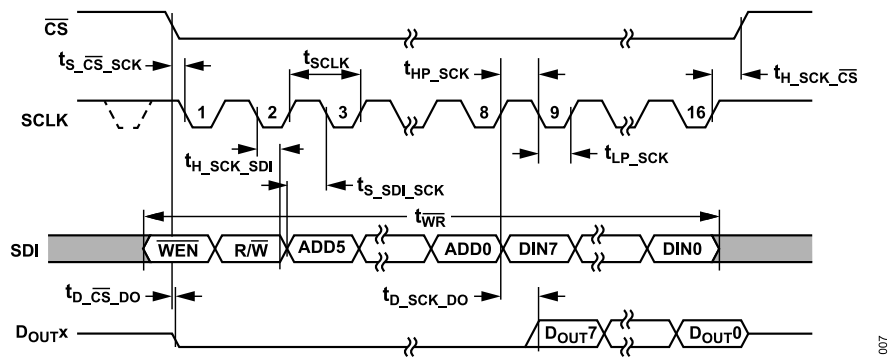

Figure 7. Serial Interface Timing Diagram, Register Map Read/Write Operations

## ABSOLUTE MAXIMUM RATINGS

$T_A = 25^\circ\text{C}$ , unless otherwise noted.

**Table 6. Absolute Maximum Ratings**

Parameter	Rating
$AV_{CC}$ to AGND	-0.3 V to +6.5 V
$V_{DRIVE}$ to AGND	-0.3 V to $AV_{CC} + 0.3$ V
Analog Input Voltage to AGND <sup>1</sup>	$\pm 21$ V
Digital Input Voltage to AGND	-0.3 V to $V_{DRIVE} + 0.3$ V
Digital Output Voltage to AGND	-0.3 V to $V_{DRIVE} + 0.3$ V
REFIN/REFOUT to AGND	-0.3 V to $AV_{CC} + 0.3$ V
Input Current to Any Pin Except Supplies <sup>1</sup>	$\pm 10$ mA
Operating Temperature Range	$-40^\circ\text{C}$ to $+125^\circ\text{C}$
Storage Temperature Range	$-65^\circ\text{C}$ to $+150^\circ\text{C}$
Junction Temperature	$150^\circ\text{C}$
Pb/Sn Temperature, Soldering	
Reflow (10 sec to 30 sec)	$240 (+0)^\circ\text{C}$
Pb-Free Temperature, Soldering Reflow	$260 (+0)^\circ\text{C}$

<sup>1</sup> Transient currents of up to 100 mA do not cause silicon controlled rectifier (SCR) latch-up.

Stresses at or above those listed under Absolute Maximum Ratings may cause permanent damage to the product. This is a stress rating only; functional operation of the product at these or any other conditions above those indicated in the operational section of this specification is not implied. Operation beyond the maximum operating conditions for extended periods may affect product reliability.

## THERMAL RESISTANCE

Thermal performance is directly linked to printed circuit board (PCB) design and operating environment. Close attention to PCB thermal design is required.

$\theta_{JA}$  is the natural convection junction to ambient thermal resistance measured in a one cubic foot sealed enclosure.  $\theta_{JC}$  is the junction to case thermal resistance.

**Table 7. Thermal Resistance**

Package Type	$\theta_{JA}$ <sup>1</sup>	$\theta_{JC}$	Unit
ST-64-2	40	7	$^\circ\text{C}/\text{W}$

<sup>1</sup> Simulated data based on JEDEC 2s2p thermal test PCB in a JEDEC natural convection environment.

## ELECTROSTATIC DISCHARGE (ESD) RATINGS

The following ESD information is provided for handling of ESD-sensitive devices in an ESD-protected area only.

Human body model (HBM) per ANSI/ESDA/JEDEC JS-001.

Field induced charged device model (FICDM) per ANSI/ESDA/JEDEC JS-002.

## ESD Ratings for AD7606C-16

**Table 8. AD7606C-16, 64-Lead LQFP**

ESD Model	Withstand Threshold (V)	Class
HBM		3A
All Pins Except Analog Inputs	6000	
Analog Input Pins Only	4000	
FICDM	750	C4

## ESD CAUTION



**ESD (electrostatic discharge) sensitive device.** Charged devices and circuit boards can discharge without detection. Although this product features patented or proprietary protection circuitry, damage may occur on devices subjected to high energy ESD. Therefore, proper ESD precautions should be taken to avoid performance degradation or loss of functionality.

PIN CONFIGURATION AND FUNCTION DESCRIPTIONS

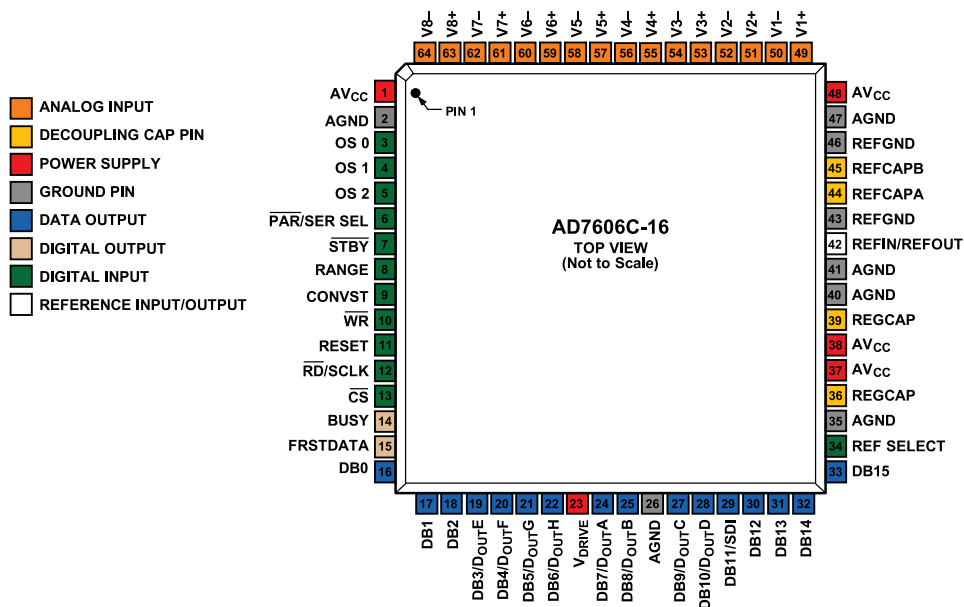

Figure 8. Pin Configuration

Table 9. Pin Function Descriptions

Pin No.	Type <sup>1</sup>	Mnemonic	Description
1, 37, 38, 48	P	AV <sub>CC</sub>	Analog Supply Voltage, 4.75 V to 5.25 V. This supply voltage is applied to the internal front-end amplifiers and to the ADC core. Decouple these supply pins to AGND.
2, 26, 35, 40, 41, 47	P	AGND	Analog Ground. The AGND pins are the ground reference points for all analog circuitry on the AD7606C-16. All analog input signals and external reference signals must be referred to the AGND pins. All six of the AGND pins must connect to the AGND plane of a system.
3 to 5	DI	OS0 to OS2	Oversampling Mode Pins. OS0 to OS2 select the oversampling ratio or enable software mode (see Table 14 for oversampling pin decoding). See the Digital Filter section for more details about the oversampling mode of operation.
6	DI	PAR/SER SEL	Parallel/Serial Interface Selection Input. If the PAR/SER SEL pin is tied to a logic low, the parallel interface is selected. If the PAR/SER SEL pin is tied to a logic high, the serial interface is selected. See the Digital Interface section for more information on each interface available.
7	DI	STBY	Standby Mode Input. In hardware mode, the STBY pin, in combination with the RANGE pin, places the AD7606C-16 in one of two power-down modes: standby mode or shutdown mode. In software mode, the STBY pin is ignored. Therefore, it is recommended to connect the STBY pin to logic high. See the Power-Down Modes section for more information on both hardware mode and software mode.
8	DI	RANGE	Analog Input Range Selection Input. In hardware mode, the RANGE pin determines the input range of the analog input channels (see Table 10). If the STBY pin is at logic low, the RANGE pin determines the power-down mode (see Table 16). In software mode, the RANGE pin is ignored. However, the RANGE pin must be tied high or low.
9	DI	CONVST	Conversion Start Input. When the CONVST pin transitions from low to high, the analog input is sampled on all eight SAR ADCs. In software mode, the CONVST pin can be configured as an external oversampling clock. Providing a low jitter external clock improves the SNR performance for large oversampling ratios. See the External Oversampling Clock section for further details.
10	DI	WR	Parallel Write Control Input. In hardware mode, the WR pin has no function. Therefore, the WR pin can be tied high, tied low, or shorted to CONVST. In software mode, the WR pin is an active low write pin for writing registers using the parallel interface. See the Parallel Interface section for more information.
11	DI	RESET	Reset Input, Active High. Full and partial reset options are available. The type of reset is determined by the length of the reset pulse. Ensure that the device receives a full reset pulse after power-up. See the Reset Functionality section for further details.
12	DI	RD/SCLK	Parallel Data Read Control Input (RD) when the Parallel Interface is Selected. Serial Clock Input (SCLK) when the Serial Interface is Selected. See the Digital Interface section for more details.
13	DI	CS	Chip Select. The CS pin is the active low chip select input for ADC data reads or register data reads and writes, in both serial and parallel interfaces. See the Digital Interface section for more details.

## PIN CONFIGURATION AND FUNCTION DESCRIPTIONS

Table 9. Pin Function Descriptions (Continued)

Pin No.	Type <sup>1</sup>	Mnemonic	Description
14	DO	BUSY	Busy Output. The BUSY pin transitions to a logic high along with the CONVST rising edge. The BUSY output remains high until the conversion process for all channels is complete.
15	DO	FRSTDATA	First Data Output. The FRSTDATA output signal indicates when the first channel, V1, is being read back on the parallel interface (see Figure 3) or the serial interface (see Figure 6). See the Digital Interface section for more details.
16 to 18	DO/DI	DB0 to DB2	Parallel Output/Input Data Bits. When using the parallel interface, the DB0 to DB2 pins act as three-state parallel digital input and output pins (see the Parallel Interface section). When $\overline{CS}$ and $\overline{RD}$ are low, the DB0 to DB2 pins are used to output DB0 to DB2 of the conversion. When using the serial interface, tie the DB0 to DB2 pins to AGND.
19	DO/DI	DB3/D <sub>OUT</sub> E	Parallel Output/Input Data Bit 3/Serial Interface Data Output Pin. When using the parallel interface, the DB3/D <sub>OUT</sub> E pin acts as a three-state parallel digital input/output pin. When $\overline{CS}$ and $\overline{RD}$ are low, the DB3/D <sub>OUT</sub> E pin is used to output DB3 of the conversion result. When using the serial interface, the DB3/D <sub>OUT</sub> E pin functions as D <sub>OUT</sub> E. See Table 23 for more details on each data interface and operation mode.
20	DO/DI	DB4/D <sub>OUT</sub> F	Parallel Output/Input Data Bit 4/Serial Interface Data Output Pin. When using the parallel interface, the DB4/D <sub>OUT</sub> F pin acts as a three-state parallel digital input/output pin. When $\overline{CS}$ and $\overline{RD}$ are low, the DB4/D <sub>OUT</sub> F pin is used to output DB4 of the conversion result. When using the serial interface, the DB4/D <sub>OUT</sub> F pin functions as D <sub>OUT</sub> F. See Table 23 for more details on each data interface and operation mode.
21	DO/DI	DB5/D <sub>OUT</sub> G	Parallel Output/Input Data Bit 5/Serial Interface Data Output Pin. When using the parallel interface, the DB5/D <sub>OUT</sub> G pin acts as a three-state parallel digital input/output pin. When $\overline{CS}$ and $\overline{RD}$ are low, the DB5/D <sub>OUT</sub> G pin is used to output DB5 of the conversion result. When using the serial interface, the DB5/D <sub>OUT</sub> G pin functions as D <sub>OUT</sub> G. See Table 23 for more details on each data interface and operation mode.
22	DO/DI	DB6/D <sub>OUT</sub> H	Parallel Output/Input Data Bit 6/Serial Interface Data Output Pin. When using the parallel interface, the DB6/D <sub>OUT</sub> H pin acts as a three-state parallel digital input/output pin. When $\overline{CS}$ and $\overline{RD}$ are low, the DB6/D <sub>OUT</sub> H pin is used to output DB6 of the conversion result. When using the serial interface, the DB6/D <sub>OUT</sub> H pin functions as D <sub>OUT</sub> H. See Table 23 for more details on each data interface and operation mode.
23	P	V <sub>DRIVE</sub>	Logic Power Supply Input. The voltage (1.71 V to 5.25 V) supplied at the V <sub>DRIVE</sub> pin determines the operating voltage of the interface. The V <sub>DRIVE</sub> pin is nominally at the same supply as the supply of the host interface, that is, the data signal processor (DSP) and field programmable gate array (FPGA).
24	DO/DI	DB7/D <sub>OUT</sub> A	Parallel Output/Input Data Bit 7/Serial Interface Data Output Pin. When using the parallel interface, the DB7/D <sub>OUT</sub> A pin acts as a three-state parallel digital input/output pin. When $\overline{CS}$ and $\overline{RD}$ are low, the DB7/D <sub>OUT</sub> A pin is used to output DB7 of the conversion result. When using the serial interface, the DB7/D <sub>OUT</sub> A pin functions as D <sub>OUT</sub> A. See Table 23 for more details on each data interface and operation mode.
25	DO/DI	DB8/D <sub>OUT</sub> B	Parallel Output/Input Data Bit 8/Serial Interface Data Output Pin. When using the parallel interface, the DB8/D <sub>OUT</sub> B pin acts as a three-state parallel digital input and output pin. When $\overline{CS}$ and $\overline{RD}$ are low, the DB8/D <sub>OUT</sub> B pin is used to output DB8 of the conversion result. When using the serial interface, the DB8/D <sub>OUT</sub> B pin functions as D <sub>OUT</sub> B. See Table 23 for more details on each data interface and operation mode.
27	DO/DI	DB9/D <sub>OUT</sub> C	Parallel Output/Input Data Bit 9/Serial Interface Data Output Pin. When using the parallel interface, the DB9/D <sub>OUT</sub> C pin acts as a three-state parallel digital input and output pin. When $\overline{CS}$ and $\overline{RD}$ are low, the DB9/D <sub>OUT</sub> C pin is used to output DB9 of the conversion result. When using the serial interface, the DB9/D <sub>OUT</sub> C pin functions as D <sub>OUT</sub> C if in software mode and using the 4 D <sub>OUT</sub> X line option or 8 D <sub>OUT</sub> X line option. See Table 23 for more details on each data interface and operation mode.
28	DO/DI	DB10/D <sub>OUT</sub> D	Parallel Output/Input Data Bit 10/Serial Interface Data Output Pin. When using the parallel interface, the DB10 pin acts as a three-state parallel digital input/output pin. When $\overline{CS}$ and $\overline{RD}$ are low, the DB10/D <sub>OUT</sub> D pin is used to output DB10 of the conversion result. When using serial interface, the DB10/D <sub>OUT</sub> D pin functions as D <sub>OUT</sub> D if in software mode and using the 4 D <sub>OUT</sub> X line option or 8 D <sub>OUT</sub> X line option. See Table 23 for more details on each data interface and operation mode.
29	DO/DI	DB11/SDI	Parallel Output/Input Data Bit 11/Serial Data Input. When using parallel interface, the DB11/SDI pin acts as a three-state parallel digital input and output pin. When $\overline{CS}$ and $\overline{RD}$ are low, the DB11/SDI pin is used to output DB11 of the conversion result. When using the serial interface in software mode, the DB11/SDI pin functions as SDI. See Table 23 for more details on each data interface and operation mode.
30, 31	DO/DI	DB12, DB13	Parallel Output/Input Data Bits. When using the parallel interface, the DB12 and DB13 pins act as three-state parallel digital input and output pins (see the Parallel Interface section). When $\overline{CS}$ and $\overline{RD}$ are low, the DB12 and DB13 pins are



## PIN CONFIGURATION AND FUNCTION DESCRIPTIONS

Table 9. Pin Function Descriptions (Continued)

Pin No.	Type <sup>1</sup>	Mnemonic	Description
			used to output DB12 and DB13 of the conversion result. When using the serial interface, tie the DB12 and DB13 pins to AGND.
32	DO/DI	DB14	Parallel Output/Input Data Bits. When using the parallel interface, the DB14 pin acts as a three-state parallel digital input and output pin (see the <a href="#">Parallel Interface</a> section). When $\overline{CS}$ and $\overline{RD}$ are low, the DB14 pin is used to output of the conversion result. When using the serial interface, tie the DB14 pin to AGND.
33	DO/DI	DB15	Parallel Output/Input Data Bits. When using the parallel interface, the DB15 pin acts as a three-state parallel digital input and output pin (see the <a href="#">Parallel Interface</a> section). When $\overline{CS}$ and $\overline{RD}$ are low, the DB15 pin is used to output DB15 of the conversion result. When using the serial interface, tie the DB15 pin to AGND.
34	DI	REF SELECT	Internal/External Reference Selection Logic Input. If the REF SELECT pin is set to logic high, the internal reference is selected and enabled. If the REF SELECT pin is set to logic low, the internal reference is disabled and an external reference voltage must be applied to the REFIN/REFOUT pin.
36, 39	P	REGCAP	Decoupling Capacitor Pin for Voltage Output from 1.9 V Internal Regulator, Analog Low Dropout (ALDO) and Digital Low Dropout (DLDO). The REGCAP output pins must be decoupled separately to AGND using a 1 $\mu$ F capacitor. The voltage on the REGCAP pins is in the range of 1.875 V to 1.93 V.
42	REF	REFIN/REFOUT	Reference Input (REFIN)/Reference Output (REFOUT). The internal 2.5 V reference is available on the REFOUT pin for external use while the REF SELECT pin is set to logic high. Alternatively, by setting the REF SELECT pin to logic low, the internal reference is disabled and an external reference of 2.5 V must be applied to this input (REFIN). A 100 nF capacitor must be applied from the REFIN pin to ground, close to the REFGND pins, for both internal and external reference options. See the <a href="#">Reference</a> section for more details.
43, 46	REF	REFGND	Reference Ground Pins. The REFGND pins must be connected to AGND.
44, 45	REF	REFCAPA, REFCAPB	Reference Buffer Output Force and Sense Pins. The REFCAPA and REFCAPB pins must be connected together and decoupled to AGND using a low effective series resistance (ESR), 10 $\mu$ F ceramic capacitor. The voltage on the REFCAPA and REFCAPB pins is typically 4.4 V.
49	AI	V1+	Channel 1 Positive Analog Input Pin.
50	AI	V1-	Channel 1 Negative Analog Input Pin.
51	AI	V2+	Channel 2 Positive Analog Input Pin.
52	AI	V2-	Channel 2 Negative Analog Input Pin.
53	AI	V3+	Channel 3 Positive Analog Input Pin.
54	AI	V3-	Channel 3 Negative Analog Input Pin.
55	AI	V4+	Channel 4 Positive Analog Input Pin.
56	AI	V4-	Channel 4 Negative Analog Input Pin.
57	AI	V5+	Channel 5 Positive Analog Input Pin.
58	AI	V5-	Channel 5 Negative Analog Input Pin.
59	AI	V6+	Channel 6 Positive Analog Input Pin.
60	AI	V6-	Channel 6 Negative Analog Input Pin.
61	AI	V7+	Channel 7 Positive Analog Input Pin.
62	AI	V7-	Channel 7 Negative Analog Input Pin.
63	AI	V8+	Channel 8 Positive Analog Input Pin.
64	AI	V8-	Channel 8 Negative Analog Input Pin.

<sup>1</sup> P is power supply, DI is digital input, DO is digital output, REF is reference input and output, AI is analog input, and GND is ground.

TYPICAL PERFORMANCE CHARACTERISTICS

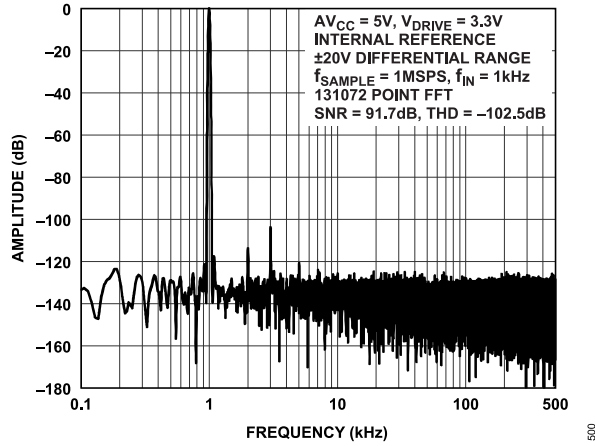

Figure 9. Fast Fourier Transform (FFT), ±20 V Range, Low Bandwidth Mode

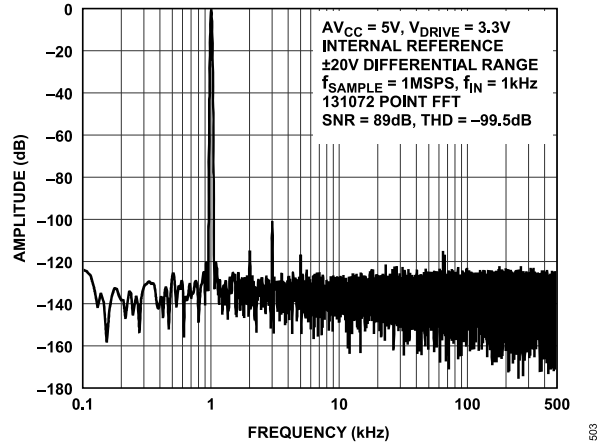

Figure 12. FFT, ±20 V Differential Range, High Bandwidth Mode

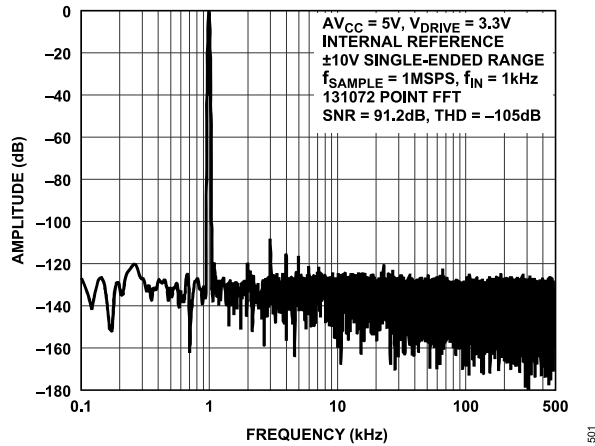

Figure 10. FFT, ±10 V Single-Ended Range, Low Bandwidth Mode

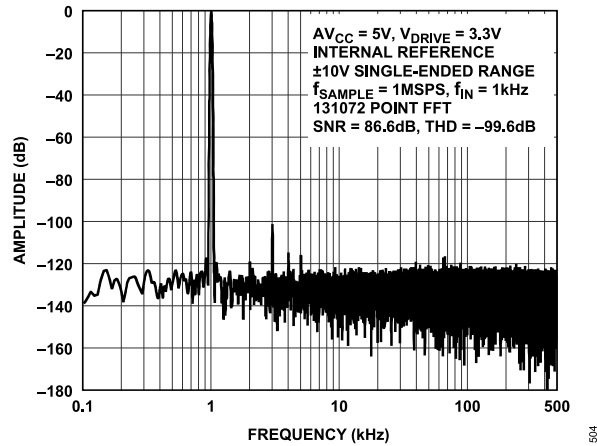

Figure 13. FFT, ±10 V Single-Ended Range, High Bandwidth Mode

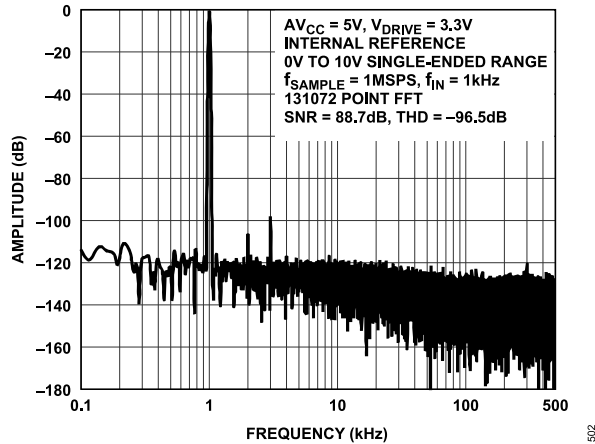

Figure 11. FFT, 0 V to 10 V Single-Ended Range, Low Bandwidth Mode

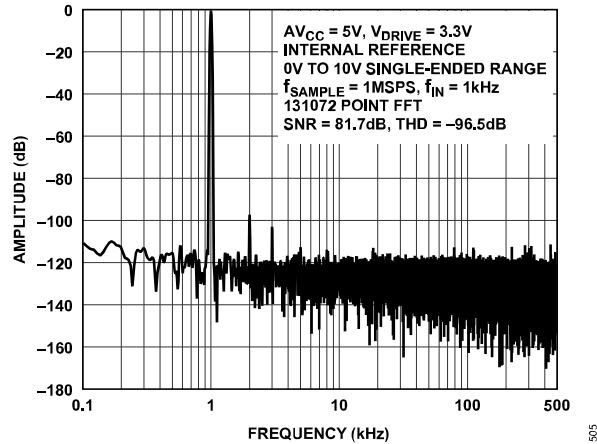

Figure 14. FFT, 0 V to 10 V Single-Ended Range, High Bandwidth Mode

TYPICAL PERFORMANCE CHARACTERISTICS

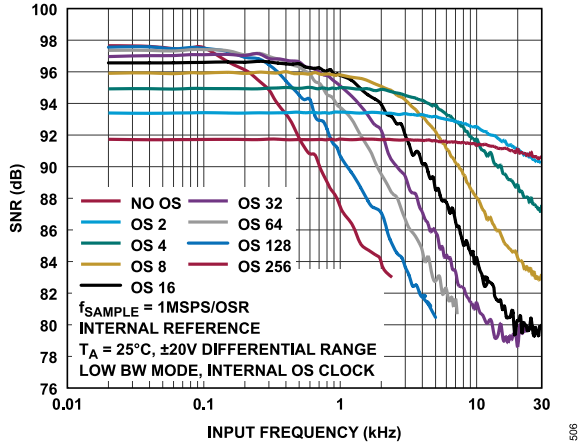

Figure 15. SNR vs. Input Frequency for Different Oversampling Ratio (OSR) Values, ±20 V Differential Range, Low Bandwidth Mode, Internal Oversampling Clock (OS = Oversampling)

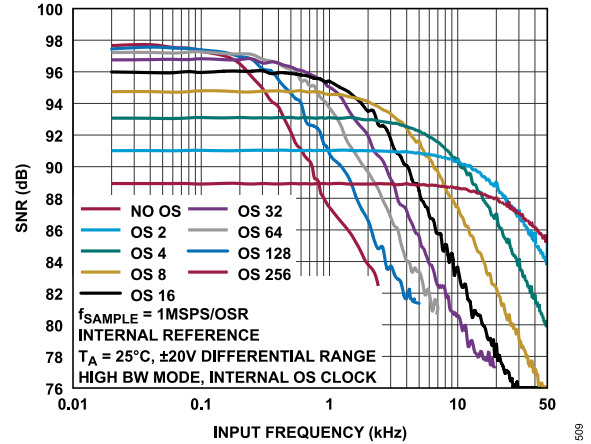

Figure 18. SNR vs. Input Frequency for Different OSR Values, ±20 V Differential Range, High Bandwidth Mode, Internal Oversampling Clock

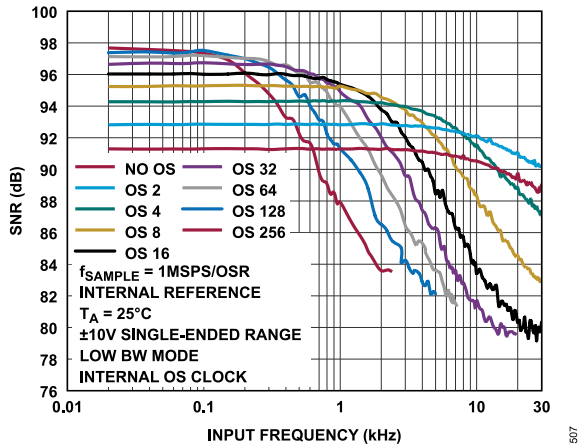

Figure 16. SNR vs. Input Frequency for Different OSR Values, ±10 V Single-Ended Range, Low Bandwidth Mode, Internal Oversampling Clock

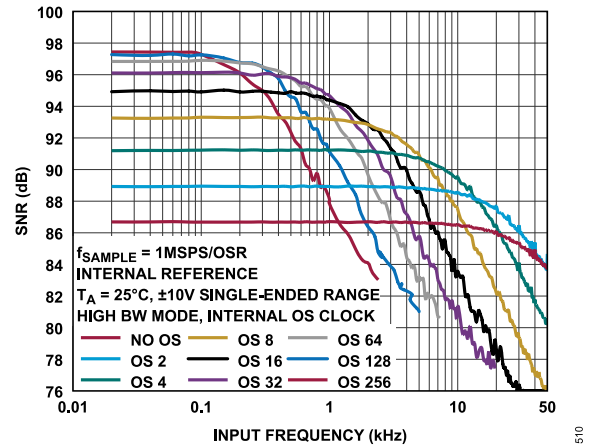

Figure 19. SNR vs. Input Frequency for Different OSR Values, ±10 V Single-Ended Range, High Bandwidth Mode, Internal Oversampling Clock

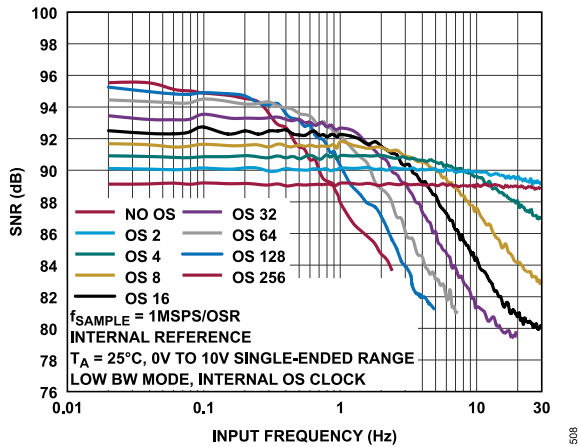

Figure 17. SNR vs. Input Frequency for Different OSR Values, 0 V to 10 V Single-Ended Range, Low Bandwidth Mode, Internal Oversampling Clock

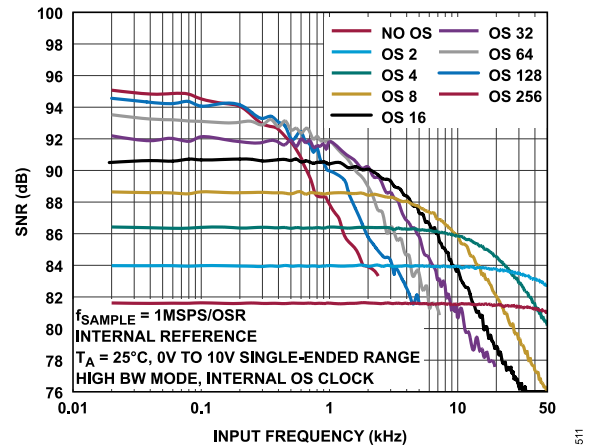

Figure 20. SNR vs. Input Frequency for Different OSR Values, 0 V to 10 V Single-Ended Range, High Bandwidth Mode, Internal Oversampling Clock

TYPICAL PERFORMANCE CHARACTERISTICS

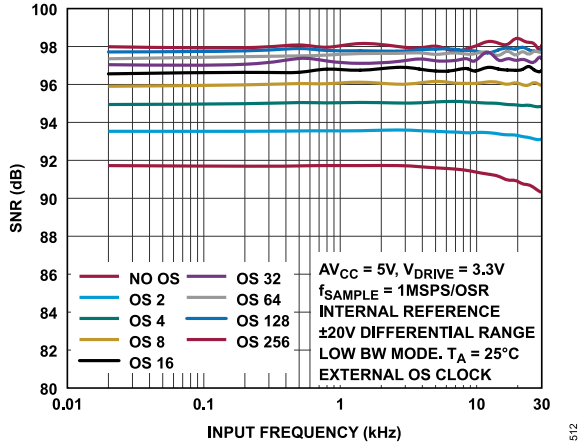

Figure 21. SNR vs. Input Frequency for Different OSR Values, ±20 V Differential Range, Low Bandwidth Mode, External Oversampling Clock

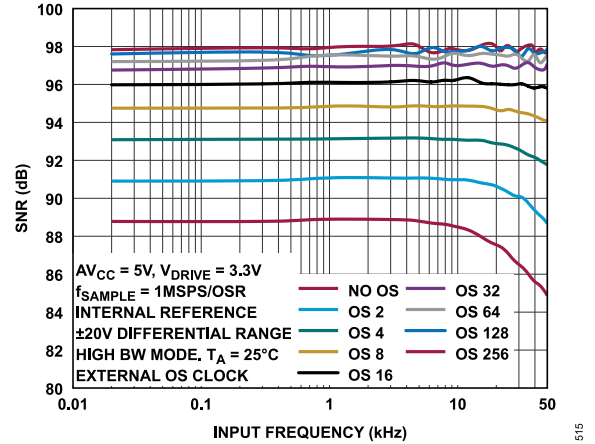

Figure 24. SNR vs. Input Frequency for Different OSR Values, ±20 V Differential Range, High Bandwidth Mode, External Oversampling Clock

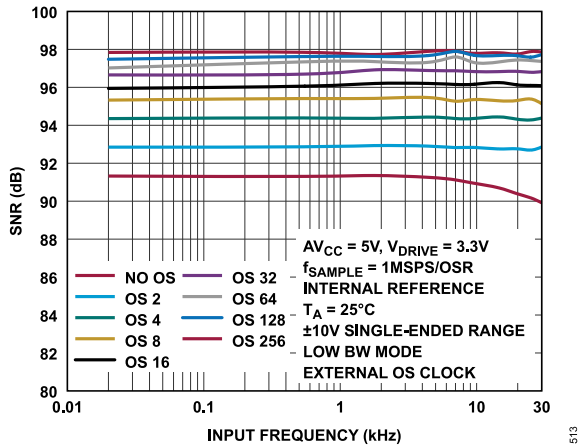

Figure 22. SNR vs. Input Frequency for Different OSR Values, ±10 V Single-Ended Range, Low Bandwidth Mode, External Oversampling Clock

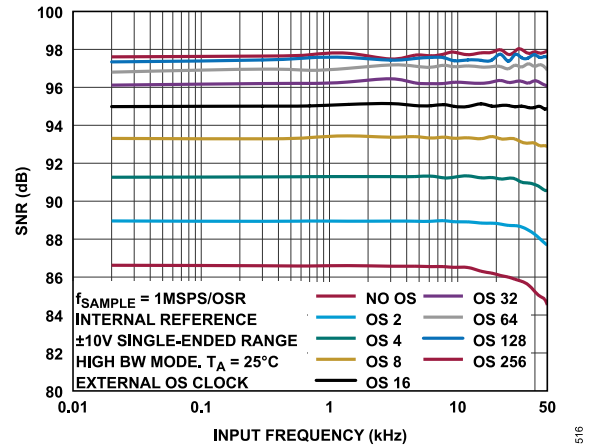

Figure 25. SNR vs. Input Frequency for Different OSR Values, ±10 V Single-Ended Range, High Bandwidth Mode, External Oversampling Clock

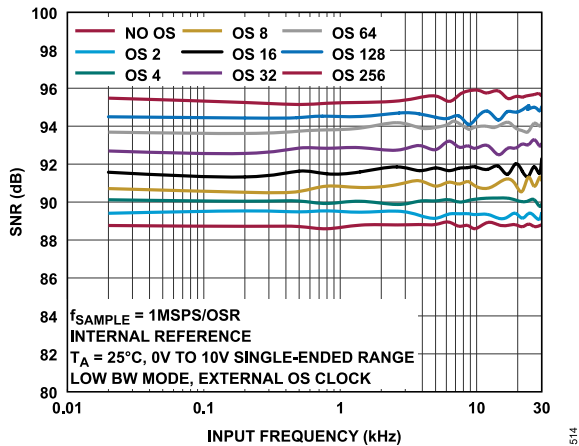

Figure 23. SNR vs. Input Frequency for Different OSR Values, 0 V to 10 V Single-Ended Range, Low Bandwidth Mode, External Oversampling Clock

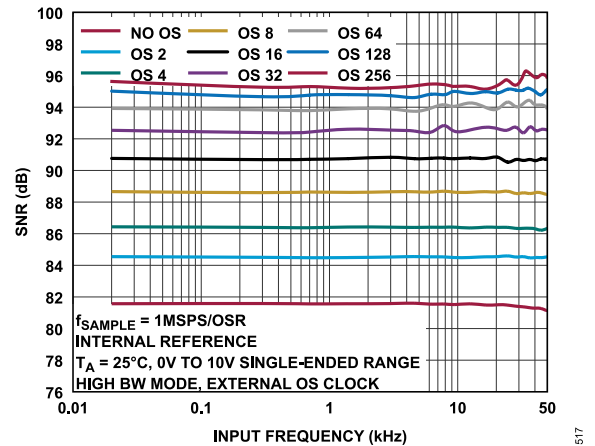

Figure 26. SNR vs. Input Frequency for Different OSR Values, 0 V to 10 V Single-Ended Range, High Bandwidth Mode, External Oversampling Clock

TYPICAL PERFORMANCE CHARACTERISTICS

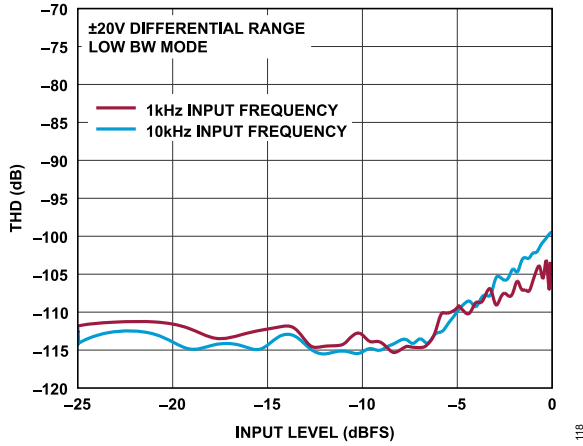

Figure 27. THD vs. Input Level, ±20 V Differential Range, Low Bandwidth Mode

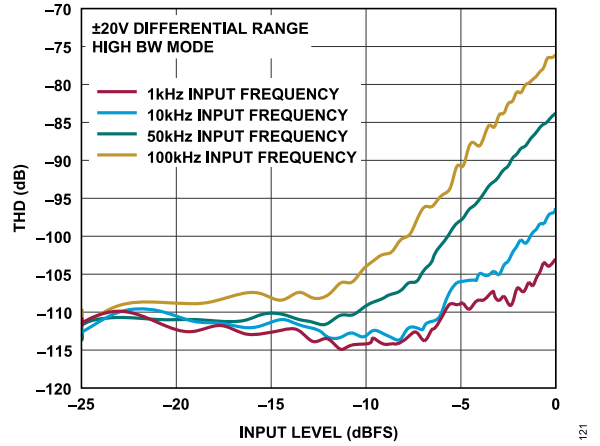

Figure 30. THD vs. Input Level, ±20 V Differential Range, High Bandwidth Mode

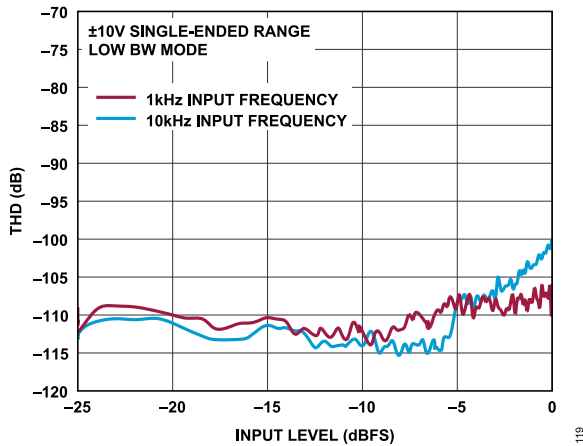

Figure 28. THD vs. Input Level, ±10 V Single-Ended Range, Low Bandwidth Mode

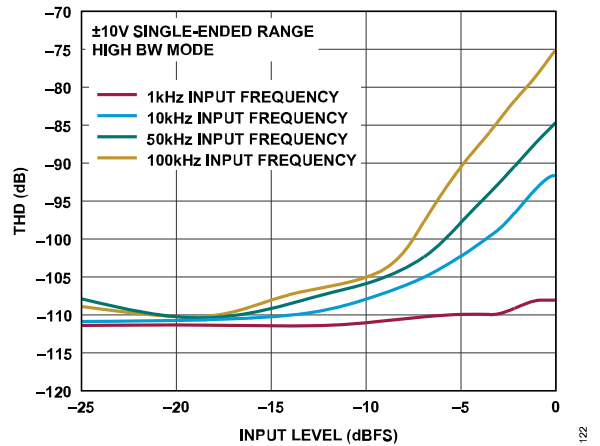

Figure 31. THD vs. Input Level, ±10 V Single-Ended Range, High Bandwidth Mode

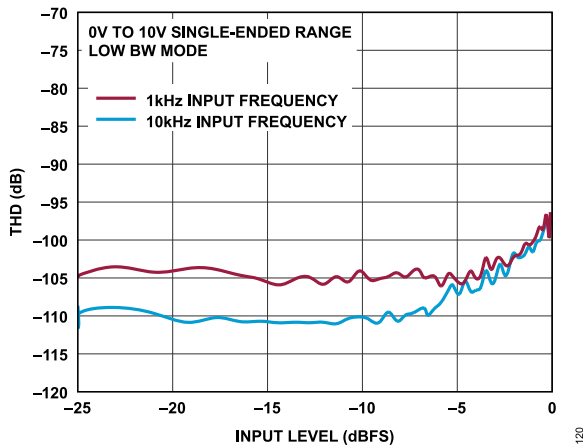

Figure 29. THD vs. Input Level, 0 V to 10 V Single-Ended Range, Low Bandwidth Mode

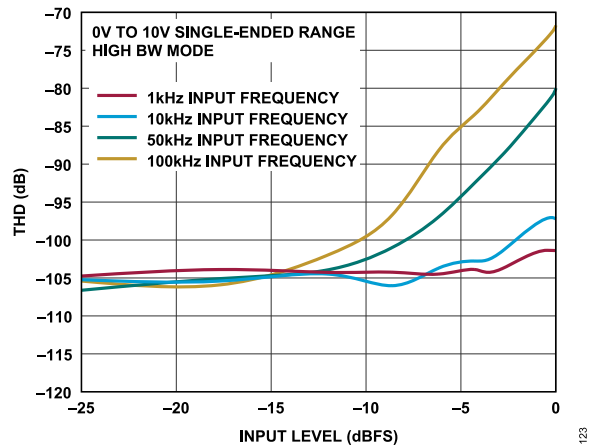

Figure 32. THD vs. Input Level, 0 V to 10 V Single-Ended Range, High Bandwidth Mode

TYPICAL PERFORMANCE CHARACTERISTICS

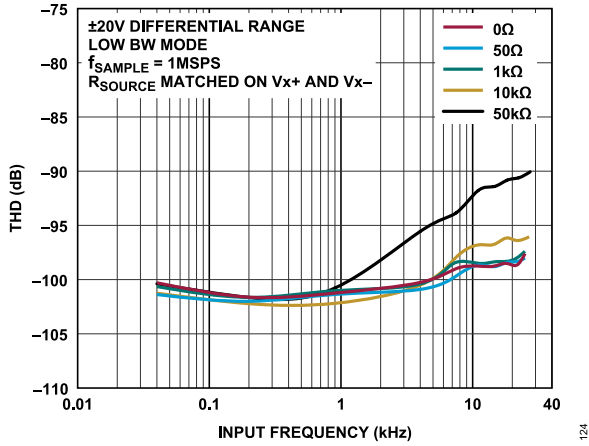

Figure 33. THD vs. Input Frequency for Various Source Impedances ( $R_{SOURCE}$ ),  $\pm 20$  V Differential Range, Low Bandwidth Mode

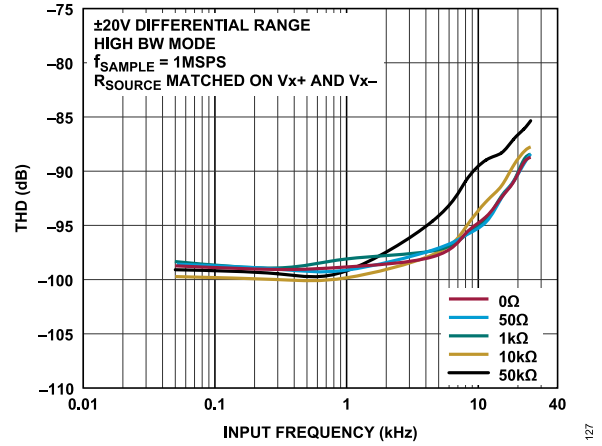

Figure 36. THD vs. Input Frequency for Various Source Impedances,  $\pm 20$  V Differential Range, High Bandwidth Mode

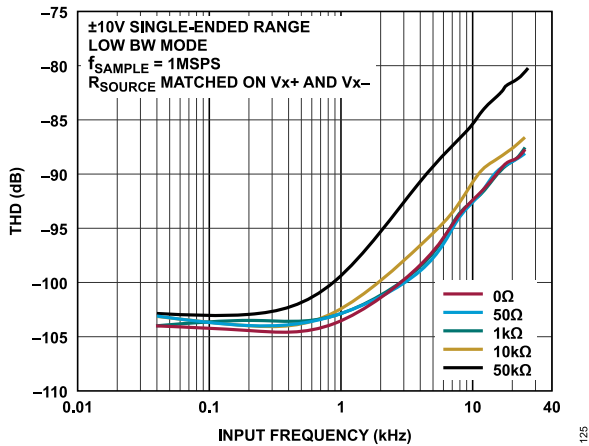

Figure 34. THD vs. Input Frequency for Various Source Impedances,  $\pm 10$  V Single-Ended Range, Low Bandwidth Mode

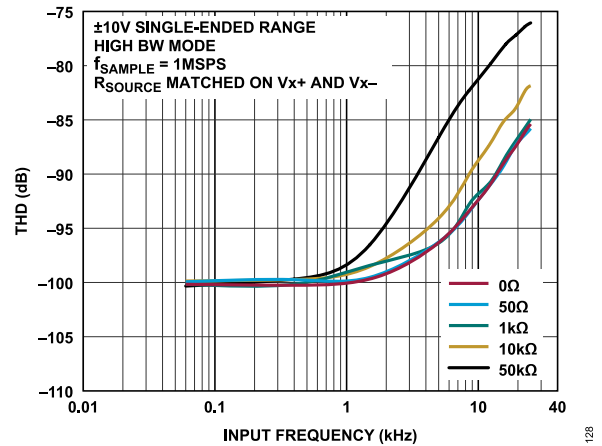

Figure 37. THD vs. Input Frequency for Various Source Impedances,  $\pm 10$  V Single-Ended Range, High Bandwidth Mode

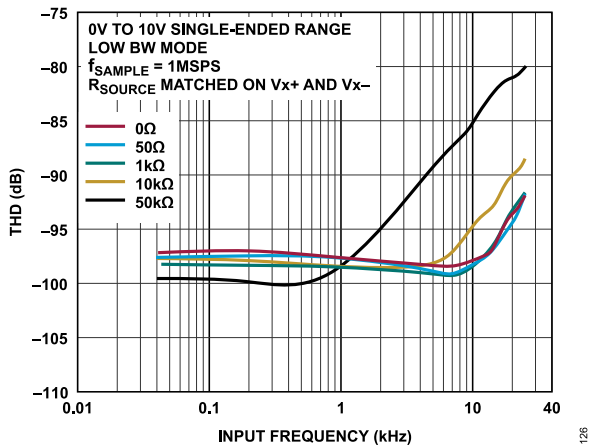

Figure 35. THD vs. Input Frequency for Various Source Impedances, 0 V to 10 V Single-Ended Range, Low Bandwidth Mode

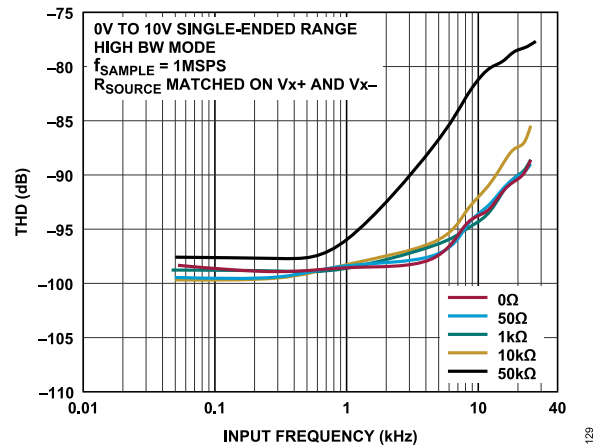

Figure 38. THD vs. Input Frequency for Various Source Impedances, 0 V to 10 V Single-Ended Range, High Bandwidth Mode

TYPICAL PERFORMANCE CHARACTERISTICS

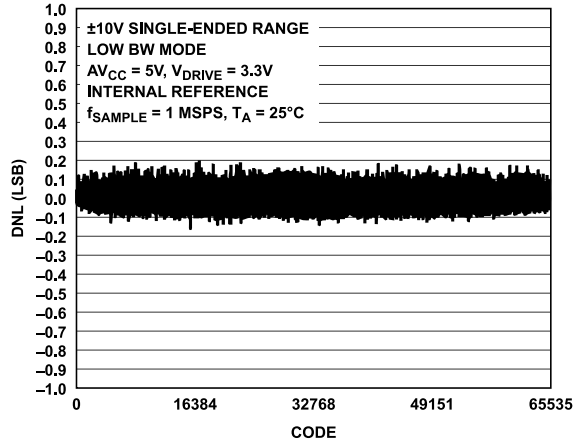

Figure 39. Typical DNL, Low Bandwidth Mode

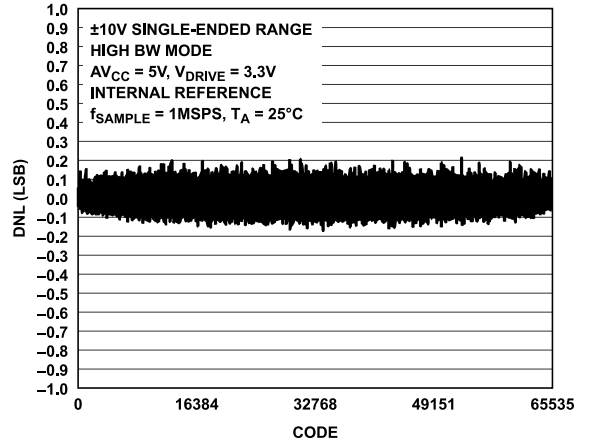

Figure 42. Typical DNL, High Bandwidth Mode

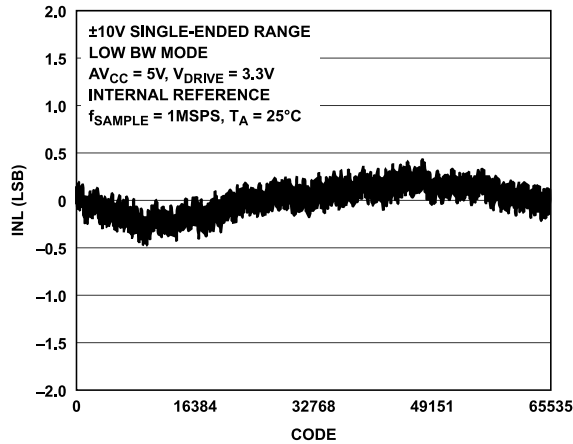

Figure 40. Typical INL, Low Bandwidth Mode

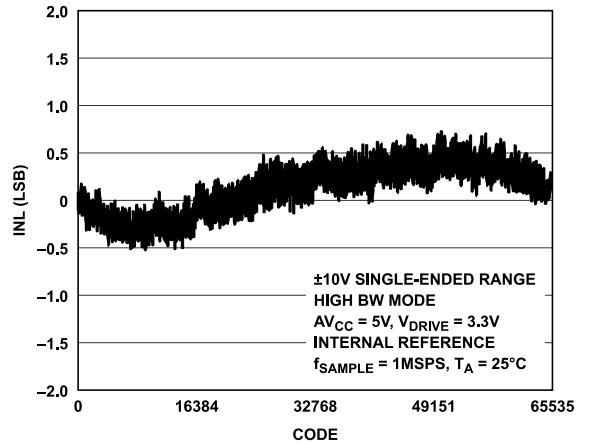

Figure 43. Typical INL, High Bandwidth Mode

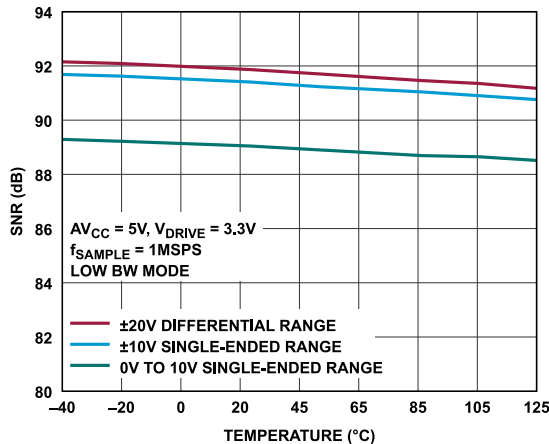

Figure 41. SNR vs. Temperature, Low Bandwidth Mode

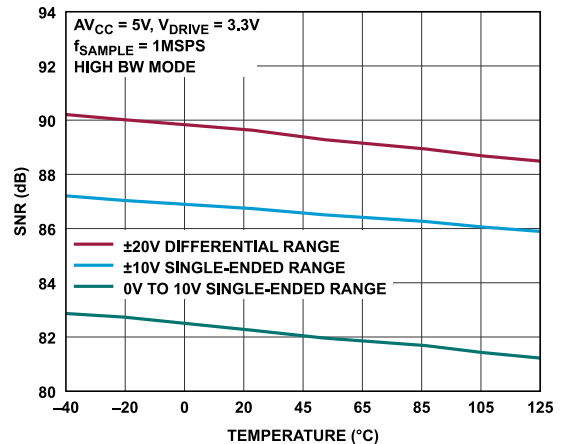

Figure 44. SNR vs. Temperature, High Bandwidth Mode

TYPICAL PERFORMANCE CHARACTERISTICS

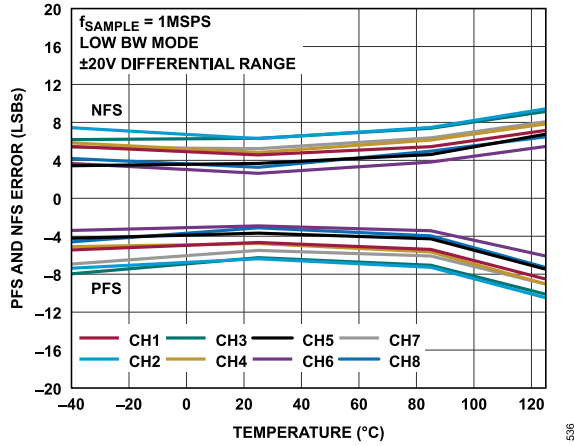

Figure 45. Positive Full-Scale (PFS) and Negative Full-Scale (NFS) Error vs. Temperature, ±20 V Differential Range

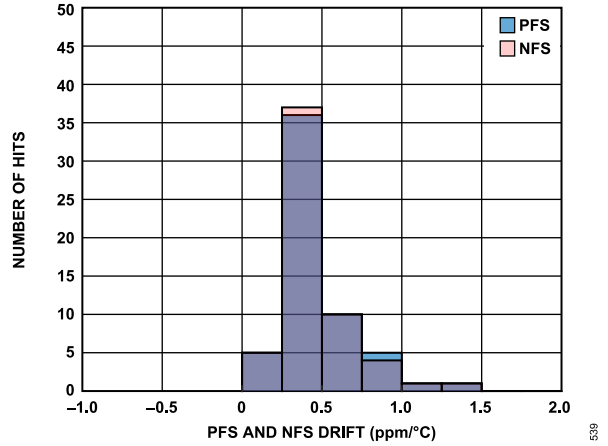

Figure 48. PFS and NFS Drift Histogram, ±10 V Single-Ended Range

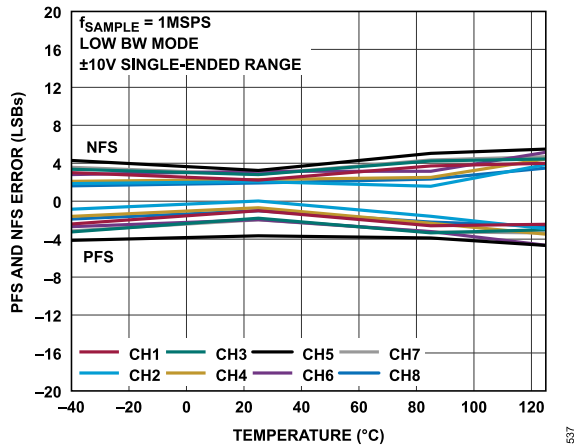

Figure 46. PFS and NFS Error vs. Temperature, ±10 V Single-Ended Range

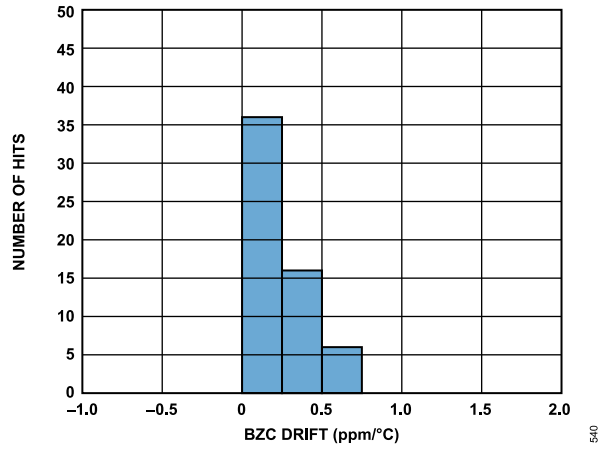

Figure 49. Bipolar Zero Code (BZC) Drift Histogram, ±10 V Single-Ended Range

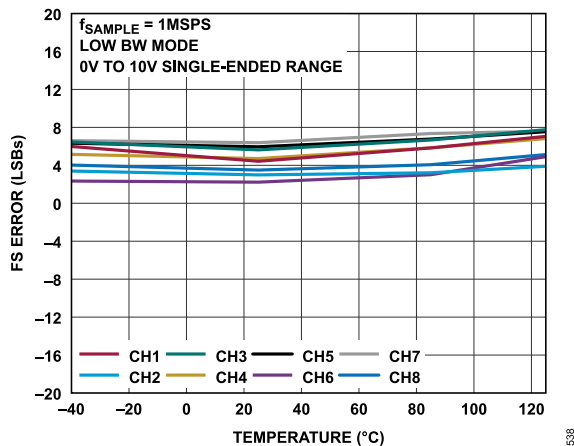

Figure 47. FS Error vs. Temperature, 0 V to 10 V Single-Ended Range

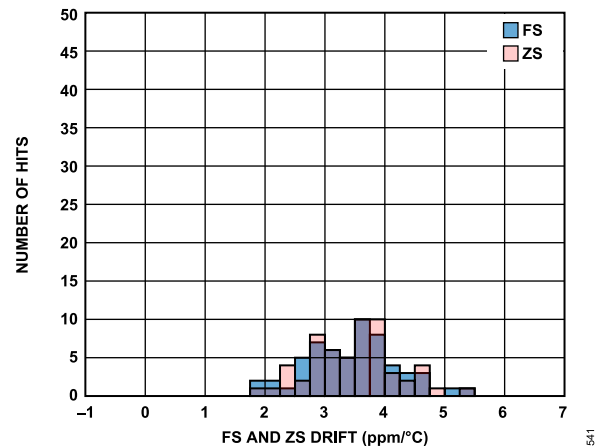

Figure 50. FS and Zero-Scale (ZS) Drift Histogram, 0 V to 10 V Single-Ended Range



TYPICAL PERFORMANCE CHARACTERISTICS

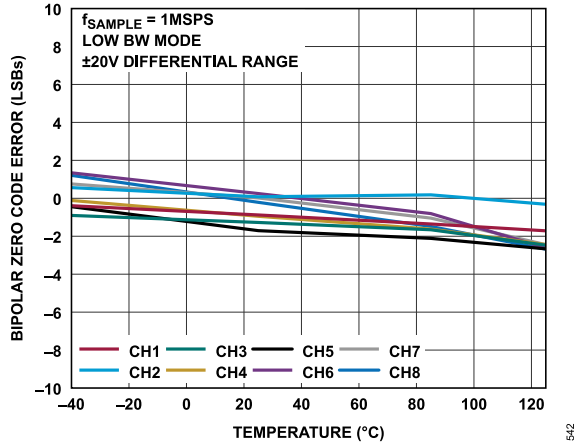

Figure 51. Bipolar Zero Code Error vs. Temperature, ±20 V Differential Range

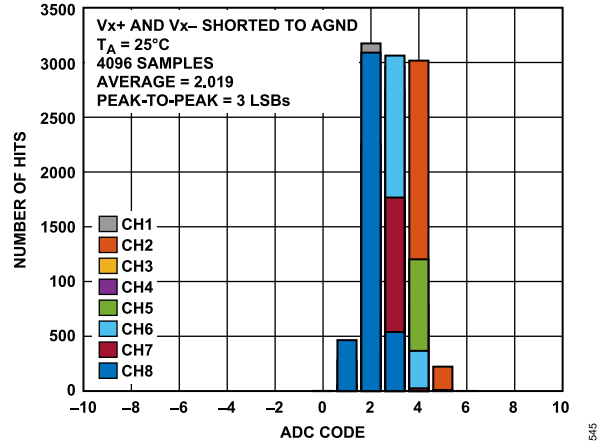

Figure 54. Histogram of Codes, ±20 V Differential Range

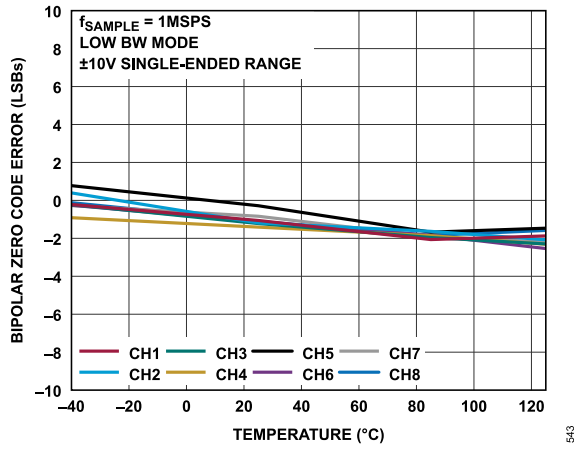

Figure 52. Bipolar Zero Code Error vs. Temperature, ±10 V Single-Ended Range

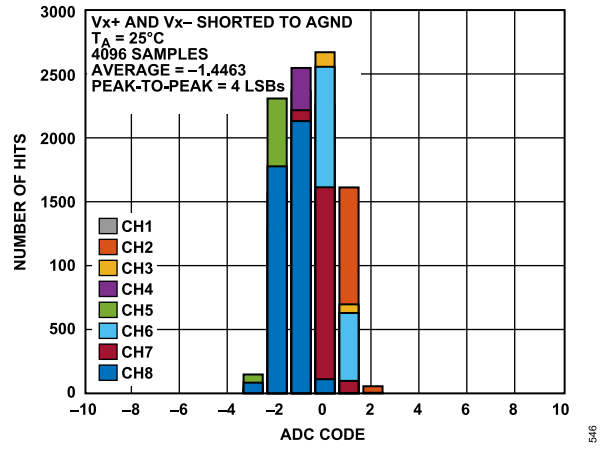

Figure 55. Histogram of Codes, ±10 V Single-Ended Range

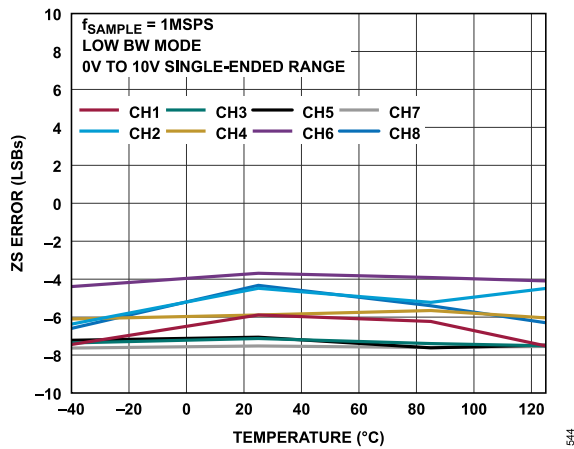

Figure 53. Zs Error vs. Temperature, 0 V to 10 V Single-Ended Range

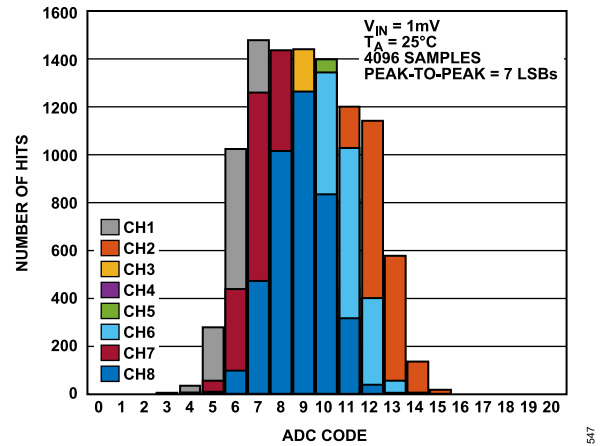

Figure 56. Histogram of Codes, 0 V to 10 V Single-Ended Range

TYPICAL PERFORMANCE CHARACTERISTICS

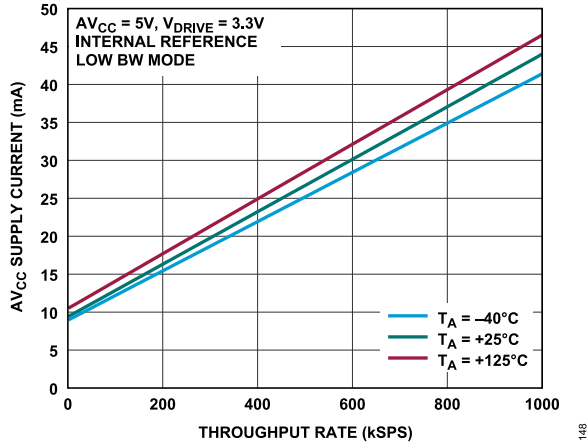

Figure 57.  $AV_{CC}$  Supply Current vs. Throughput Rate for Various Temperatures

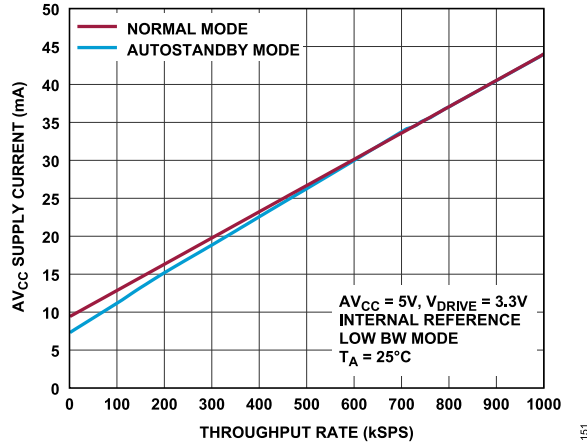

Figure 60.  $AV_{CC}$  Supply Current vs. Throughput Rate, Normal Mode and Autostandby Mode

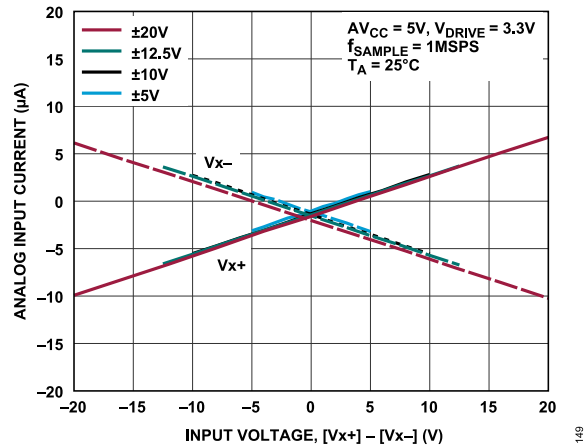

Figure 58. Analog Input Current vs. Input Voltage for Various Differential Ranges

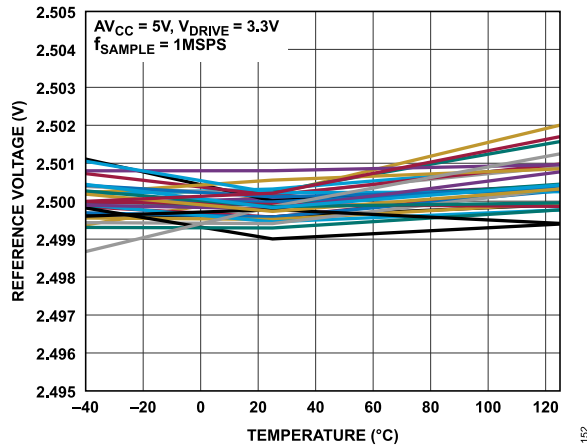

Figure 61. Reference Drift

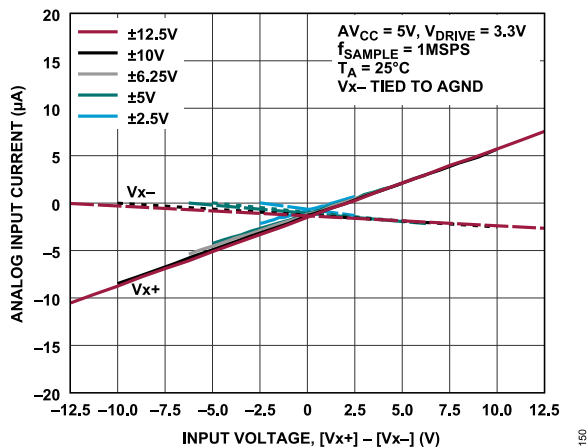

Figure 59. Analog Input Current vs. Input Voltage for Various Bipolar Single-Ended Ranges

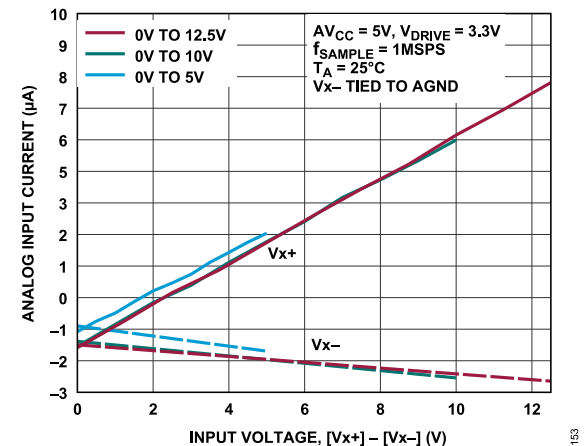

Figure 62. Analog Input Current vs. Input Voltage for Various Unipolar Single-Ended Ranges

TYPICAL PERFORMANCE CHARACTERISTICS

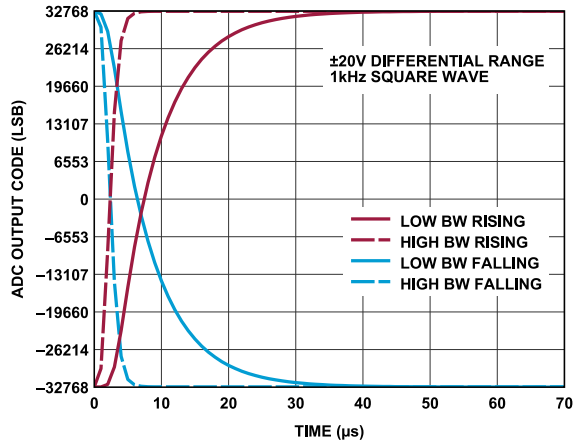

Figure 63. Step Response,  $\pm 20$  V Differential Range

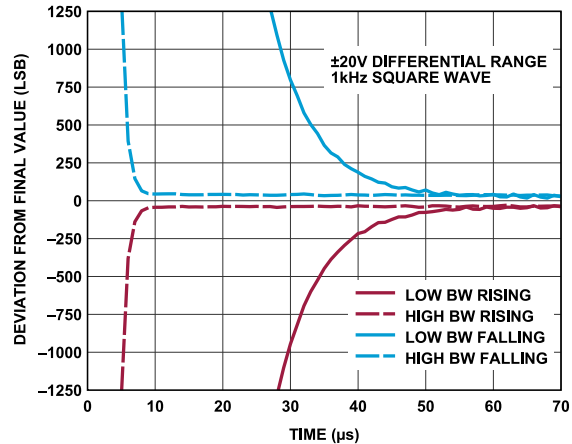

Figure 66. Step Response,  $\pm 20$  V Differential Range, Fine Settling

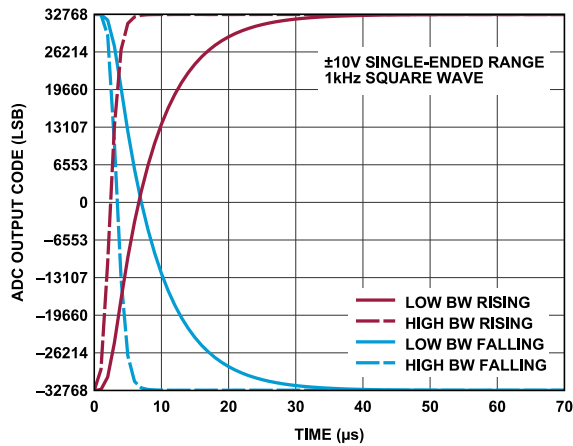

Figure 64. Step Response,  $\pm 10$  V Single-Ended Range

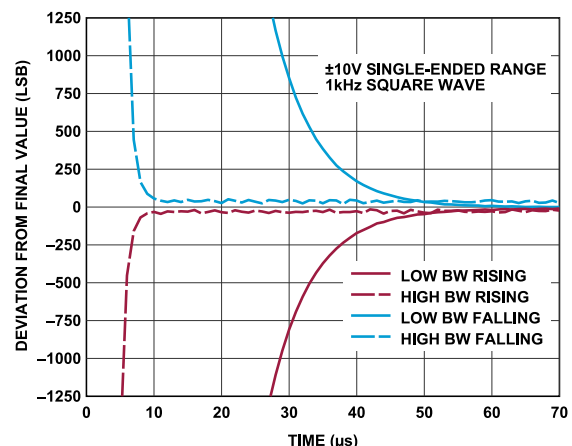

Figure 67. Step Response,  $\pm 10$  V Single-Ended Range, Fine Settling

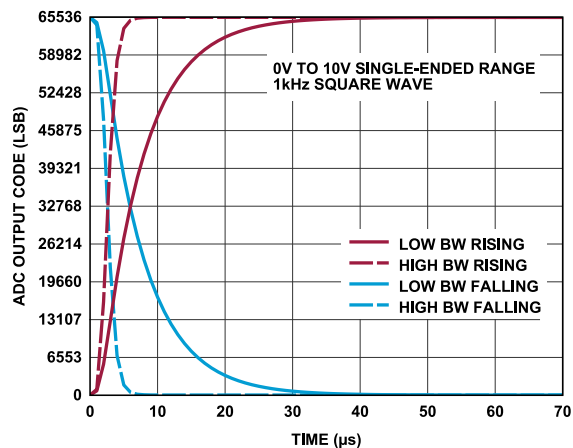

Figure 65. Step Response, 0 V to 10 V Single-Ended Range

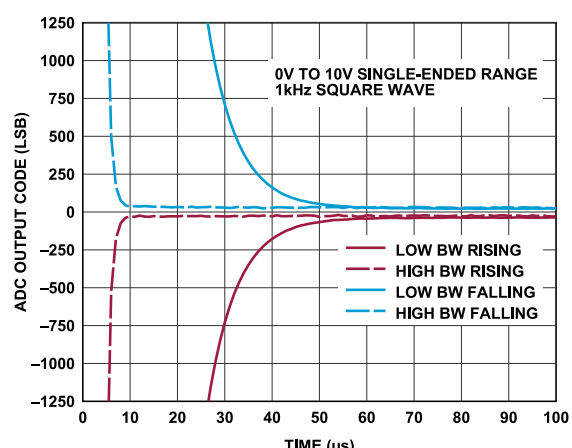

Figure 68. Step Response, 0 V to 10 V Single-Ended Range, Fine Settling

TYPICAL PERFORMANCE CHARACTERISTICS

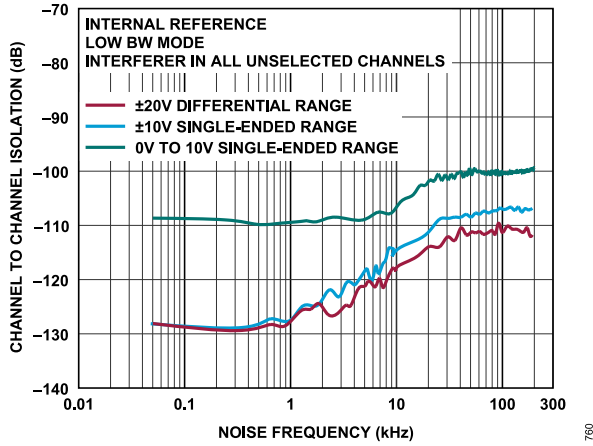

Figure 69. Channel to Channel Isolation vs. Noise Frequency, Low Bandwidth Mode

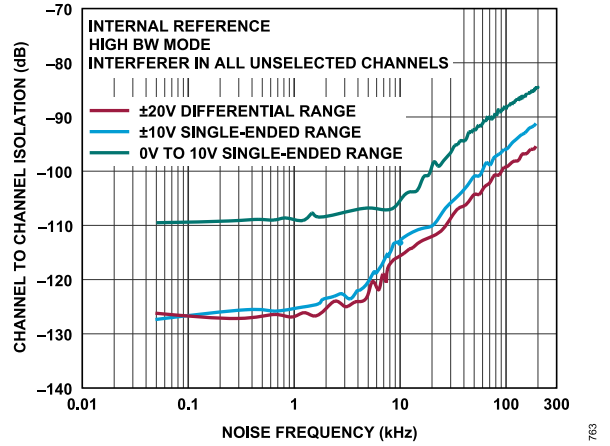

Figure 72. Channel to Channel Isolation vs. Noise Frequency, High Bandwidth Mode

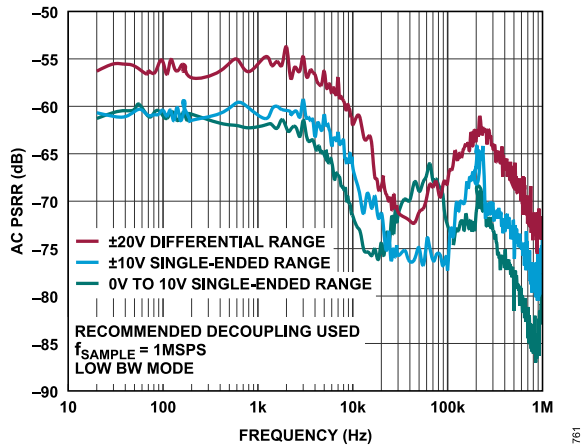

Figure 70. AC Power Supply Rejection Ratio (PSRR) vs. Frequency, Low Bandwidth Mode

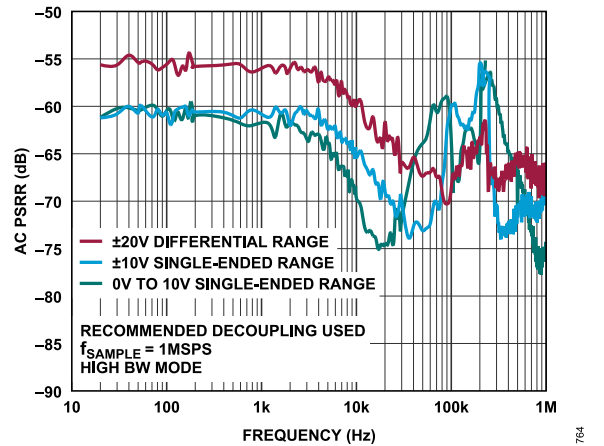

Figure 73. AC PSRR vs. Frequency, High Bandwidth Mode

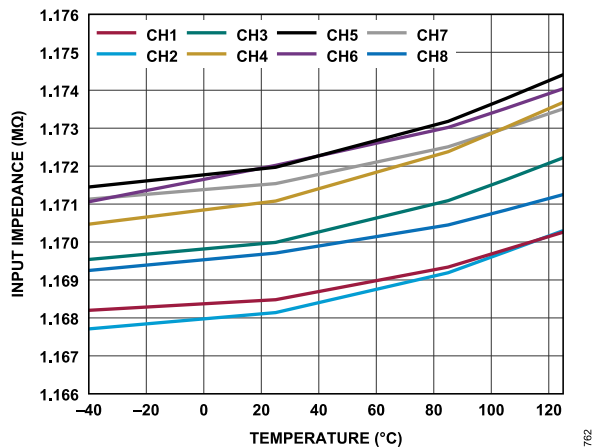

Figure 71. Input Impedance vs. Temperature

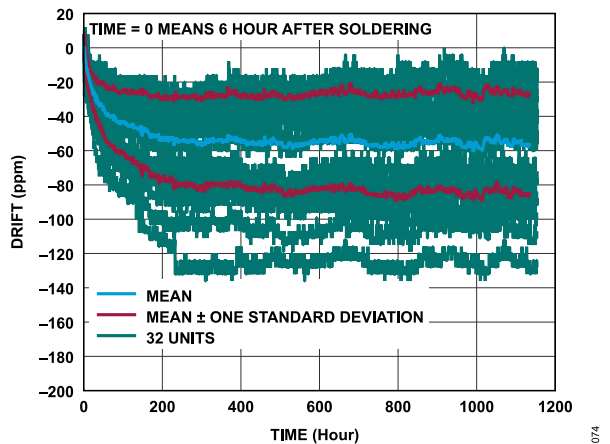

Figure 74. Long Term Drift

## TERMINOLOGY

### Integral Nonlinearity (INL)

INL is the maximum deviation from a straight line passing through the endpoints of the ADC transfer function. The endpoints of the transfer function are zero scale at  $\frac{1}{2}$  LSB below the first code transition and full scale at  $\frac{1}{2}$  LSB above the last code transition.

### Differential Nonlinearity (DNL)

DNL is the difference between the measured and the ideal 1 LSB change between any two adjacent codes in the ADC.

### Bipolar Zero Code Error

Bipolar zero code error is the deviation of the midscale transition (all 1s to all 0s) from the ideal, which is  $0\text{ V} - \frac{1}{2}$  LSB.

### Bipolar Zero Code Error Matching

Bipolar zero code error match is the absolute difference in bipolar zero code error between any two input channels.

### Open Circuit Code Error

Open circuit code error is the ADC output code when there is an open circuit on the analog input and a pull-down resistor ( $R_{PD}$ ) connected between the analog input pair of pins. See [Figure 97](#) for more details.

### Positive Full-Scale (PFS) Error

In bipolar ranges, PFS error is the deviation of the actual last code transition from the ideal last code transition (for example,  $10\text{ V} - 1\frac{1}{2}$  LSB (9.99954),  $5\text{ V} - 1\frac{1}{2}$  LSB (4.99977), or  $2.5\text{ V} - 1\frac{1}{2}$  LSB (2.49988)) after the bipolar zero code error is adjusted out. The PFS error includes the contribution from the reference buffer.

### Positive Full-Scale (PFS) Error Matching

PFS error matching is the absolute difference in PFS error between any two input channels.

### Negative Full-Scale (NFS) Error

In bipolar ranges, NFS error is the deviation of the first code transition from the ideal first code transition (for example,  $-10\text{ V} + \frac{1}{2}$  LSB (-9.99984),  $-5\text{ V} + \frac{1}{2}$  LSB (-4.99992), or  $-2.5\text{ V} + \frac{1}{2}$  LSB (-2.49996)) after the bipolar zero code error is adjusted out. The NFS error includes the contribution from the reference buffer.

### Negative Full-Scale (NFS) Error Matching

NFS error matching is the absolute difference in NFS error between any two input channels.

### Full-Scale (FS) Error

In unipolar ranges, FS error is the deviation of the actual last code transition from the ideal last code transition (for example,  $10\text{ V} - 1\frac{1}{2}$  LSB (9.99954), or  $5\text{ V} - 1\frac{1}{2}$  LSB (4.99977)) after the zero scale error is adjusted out. The FS error includes the contribution from the reference buffer.

### Zero Scale (ZS) Error

In unipolar ranges, ZS error is the deviation of the first code transition from the ideal first code transition, which is  $0\text{ V} - \frac{1}{2}$  LSB.

### Total Unadjusted Error (TUE)

TUE is the maximum deviation of the output code from the ideal. TUE includes INL errors, bipolar zero code and positive and negative full-scale errors, and reference errors.

### Signal-to-Noise and Distortion Ratio (SINAD)

SINAD ratio is the measured ratio of signal-to-noise and distortion at the output of the ADC. The signal is the RMS amplitude of the fundamental. Noise is the sum of all nonfundamental signals up to half the sampling frequency ( $f_s/2$ , excluding DC).

The ratio depends on the number of quantization levels in the digitization process: the more levels, the smaller the quantization noise.

The theoretical SINAD for an ideal N-bit converter with a sine wave input is given by

$$SINAD = (6.02 N + 1.76) \text{ (dB)} \quad (1)$$

Thus, for a 16-bit converter, the SINAD is 98 dB.

### Total Harmonic Distortion (THD)

THD is the ratio of the RMS sum of the harmonics to the fundamental. For the AD7606C-16, THD is defined as

$$THD(\text{dB}) = 20 \log \frac{\sqrt{V_2^2 + V_3^2 + V_4^2 + V_5^2 + V_6^2 + V_7^2 + V_8^2 + V_9^2}}{V_1} \quad (2)$$

where:

$V_1$  is the RMS amplitude of the fundamental.

$V_2$  to  $V_9$  are the RMS amplitudes of the second through ninth harmonics.

### Peak Harmonic or Spurious Noise

Peak harmonic or spurious noise is the ratio of the RMS value of the next largest component in the ADC output spectrum (up to  $f_s/2$ , excluding dc) to the RMS value of the fundamental. Normally, the value of this specification is determined by the largest harmonic in the spectrum, but for ADCs where the harmonics are buried in the noise floor, the value is determined by a noise peak.

### Power Supply Rejection Ratio (PSRR)

Variations in power supply affect the full-scale transition but not the linearity of the converter. The power supply rejection (PSR) is the maximum change in full-scale transition point due to a change in power supply voltage from the nominal value. The PSRR is defined as the ratio of the 100 mV p-p sine wave applied to the  $AV_{CC}$  supplies of the ADC frequency,  $f_s$ , to the power of the ADC output at that frequency,  $f_s$ .

**TERMINOLOGY**

$$PSRR \text{ (dB)} = 20 \log (0.1/Pf_S) \quad (3)$$

where:

$Pf_S$  is equal to the power at frequency,  $f_S$ , coupled on the  $AV_{CC}$  supply.

**Channel-to-Channel Isolation**

Channel-to-channel isolation is a measure of the level of crosstalk between all input channels. It is measured by applying a full-scale sine wave signal, up to 200 kHz, to all unselected input channels and then determining the degree to which the signal attenuates in the selected channel with a 1 kHz sine wave signal applied (see [Figure 69](#) and [Figure 72](#)).

**Phase Delay**

Phase delay is a measure of the absolute time delay between when an input is sampled by the converter and when the result associated with that sample is available to be read back from the ADC, including delay induced by the analog front end of the device.

**Phase Delay Drift**

Phase delay drift is the change in phase delay per unit temperature across the entire operating temperature of the device.

**Phase Delay Matching**

Phase delay matching is the maximum phase delay seen between any simultaneously sampled pair.

**Box Method**

The box method is represented by the following equation:

$$TCV_{OUT} = \frac{\left| \frac{\max\{V_{OUT}(T_1, T_2, T_3)\} - \min\{V_{OUT}(T_1, T_2, T_3)\}}{V_{OUT}(T_2) \times (T_3 - T_1)} \right|}{\times 10^6} \quad (4)$$

where:

$TCV_{OUT}$  is expressed in ppm/°C.

$V_{OUT}(T_X)$  is the output voltage at temperature  $T_X$ .

$T_1 = -40^\circ\text{C}$ .

$T_2 = +25^\circ\text{C}$ .

$T_3 = +125^\circ\text{C}$ .

This box method ensures that  $TCV_{OUT}$  accurately portrays the maximum difference between any of the three temperatures at which the output voltage of the device is measured.

## THEORY OF OPERATION

### ANALOG FRONT END

The AD7606C-16 is a 16-bit, simultaneous sampling, analog-to-digital DAS with eight channels. Each channel contains analog input clamp protection, a PGA, a low-pass filter, and a 16-bit SAR ADC.

### Analog Input Ranges

The AD7606C-16 can handle true bipolar differential, bipolar single-ended, and unipolar single-ended input voltages.

In software mode, it is possible to configure an individual analog input range per channel using Address 0x03 through Address 0x06. The logic level on the RANGE pin is ignored in software mode.

In hardware mode, the logic level on the RANGE pin determines either  $\pm 10$  V or  $\pm 5$  V single-ended as the analog input range of all analog input channels, as shown in Table 10.

A logic change on the RANGE pin has an immediate effect on the analog input range. However, there is typically a settling time of approximately 80  $\mu$ s in addition to the normal acquisition time requirement. Changing the RANGE pin during a conversion is not recommended for fast throughput rate applications.

**Table 10. Analog Input Range Selection**

Range (V)	Hardware Mode <sup>1</sup>	Software Mode <sup>2</sup>
$\pm 10$ Single-Ended	RANGE pin high	Address 0x03 through Address 0x06
$\pm 5$ Single-Ended	RANGE pin low	Address 0x03 through Address 0x06
Any Other Range	Not applicable	Address 0x03 through Address 0x06

<sup>1</sup> The same analog input range,  $\pm 10$  V or  $\pm 5$  V, applies to all eight channels.

<sup>2</sup> The analog input range is selected on a per channel basis using the memory map.

### Analog Input Impedance

The analog input impedance ( $R_{IN}$ ) of the AD7606C-16 is 1 M $\Omega$  minimum.  $R_{IN}$  is a fixed input impedance that does not vary with the AD7606C-16 sampling frequency. This high analog input impedance eliminates the need for a driver amplifier in front of the AD7606C-16, allowing direct connection to the source or sensor. Therefore, bipolar supplies can be removed from the signal chain.

### Analog Input Clamp Protection

Figure 75 shows the analog input circuitry of the AD7606C-16. Each analog input of the AD7606C-16 contains clamp protection circuitry. Despite single, 5 V supply operation, this analog input clamp protection allows an input overvoltage of up to  $\pm 21$  V.

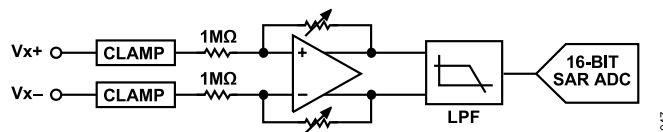

**Figure 75. Analog Input Circuitry for Each Channel**

Figure 76 shows the input clamp current vs. the source voltage characteristic of the clamp circuit. For input voltages of up to  $\pm 21$  V, no current flows in the clamp circuit. For input voltages that are above  $\pm 21$  V, the AD7606C-16 clamp circuitry turns on.

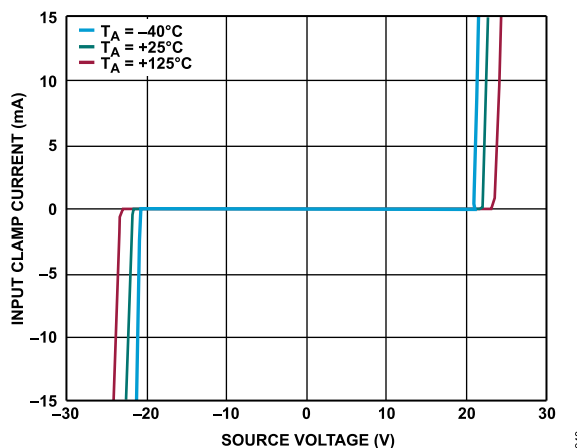

**Figure 76. Input Protection Clamp Profile**

It is recommended to place a series resistor on the analog input channels to limit the current to  $\pm 10$  mA for input voltages greater than  $\pm 21$  V. In an application where there is a series resistance ( $R$ ) on an analog input channel,  $V_{x+}$ , it is recommended to match the resistance ( $R$ ) with the resistance on  $V_{x-}$  to eliminate any offset introduced to the system, as shown in Figure 77. However, in software mode, a per channel system offset calibration removes the offset of the full system (see the System Offset Calibration section).

During normal operation, it is not recommended to leave the AD7606C-16 in a condition where the analog input is greater than the input range for extended periods of time because this condition can degrade the bipolar zero code error performance. In shutdown or standby mode, there is no such concern.

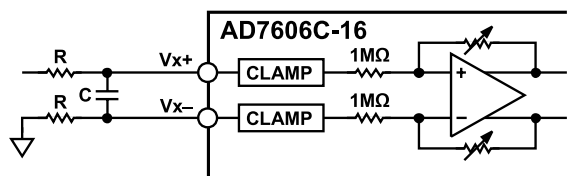

**Figure 77. Input Resistance Matching on the Analog Input of the AD7606C-16 for Single-Ended Ranges ( $V_{x-}$  Tied to Ground)**

**THEORY OF OPERATION**

**PGA**

A PGA is provided at each input channel. The gain is configured depending on the analog input range selected (see Table 10) to scale the analog input signal, either bipolar differential or bipolar or unipolar single-ended, to the ADC fully differential input range.

Input impedance on each input of the PGA is accurately trimmed to maintain the overall gain error. This trimmed value is then used when the gain calibration is enabled to compensate for the gain error introduced by an external series resistor. See the System Gain Calibration section for more information on the PGA feature.

**Analog Input Antialiasing Filter**

An analog antialiasing filter is provided on the AD7606C-16. Figure 78 and Figure 79 show the frequency response and phase response, respectively, of the analog antialiasing filter. The -3 dB frequency is typically 25 kHz.

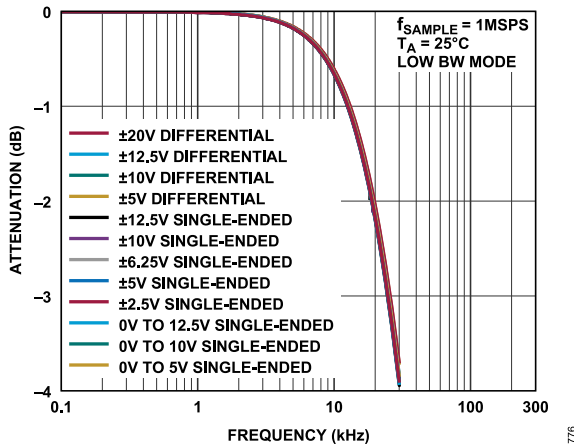

Figure 78. Analog Antialiasing Filter Frequency Response, Low Bandwidth Mode

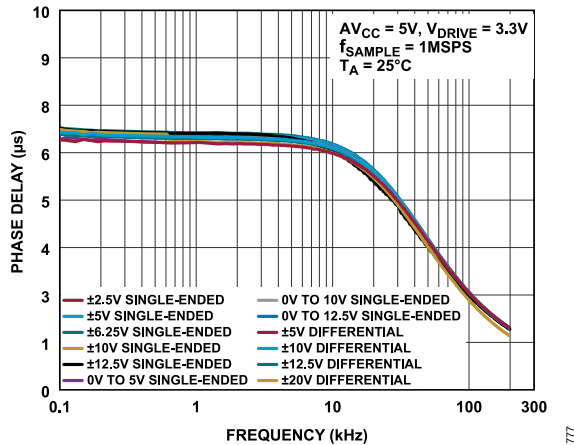

Figure 79. Analog Antialiasing Filter Phase Response, Low Bandwidth Mode

In addition, the AD7606C-16 allows the ADC to enable the high bandwidth mode, on a per channel basis, that moves the -3 dB

frequency up to 220 kHz, as shown in Figure 80 and Figure 81. This mode is dedicated for fast analog input settling applications, as shown in Figure 63 to Figure 68.

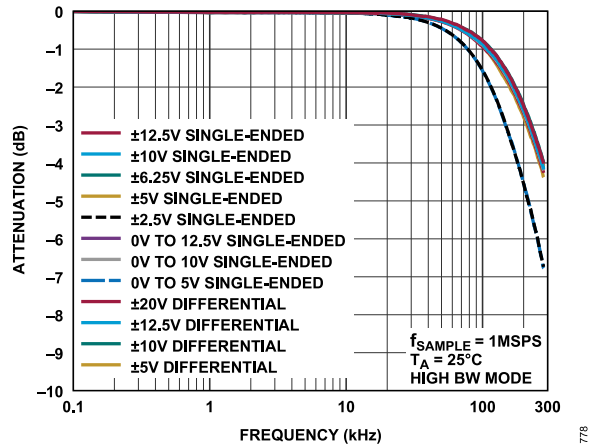

Figure 80. Analog Antialiasing Filter Frequency Response, High Bandwidth Mode

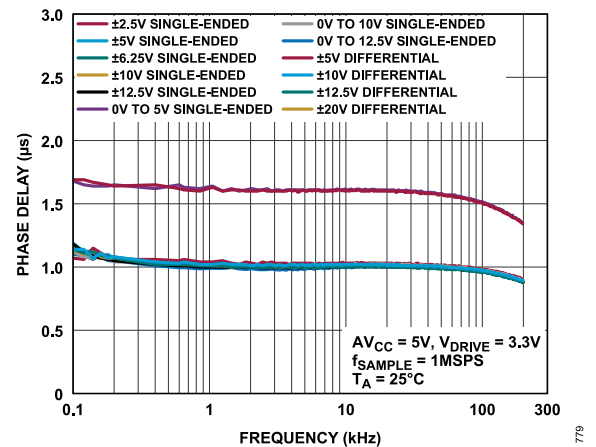

Figure 81. Analog Antialiasing Filter Phase Response, High Bandwidth Mode

**SAR ADC**

The AD7606C-16 allows the ADC to accurately acquire an input signal of full-scale amplitude to 16-bit resolution. All eight SAR ADCs sample the respective inputs simultaneously on the rising edge of the CONVST signal.

The BUSY signal indicates when conversions are in progress. Therefore, when the rising edge of the CONVST signal is applied, the BUSY pin goes logic high and transitions low at the end of the entire conversion process. The end of the conversion process across all eight channels is indicated by the falling edge of the BUSY signal. When the BUSY signal edge falls, the acquisition time for the next set of conversions begins. The rising edge of the CONVST signal has no effect while the BUSY signal is high.

New data can be read from the output register through the parallel or serial interface after the BUSY output goes low. Alternatively,



**THEORY OF OPERATION**

data from the previous conversion can be read while the BUSY pin is high, as explained in the [Reading During Conversion](#) section.

The AD7606C-16 contains an on-chip oscillator that performs the conversions. The conversion time for all ADC channels is  $t_{CONV}$  (see [Table 3](#)). In software mode, there is an option to apply an external clock through the CONVST pin. Providing a low jitter external clock improves SNR performance for large OSRs. See the [Digital Filter](#) section and [Figure 15](#) to [Figure 18](#) for further information.

Connect all unused analog input channels to AGND. The results for any unused channels are still included in the data read because all channels are always converted.

**ADC Transfer Function**

The output coding of the AD7606C-16 is twos complement for the bipolar analog input ranges, either single-ended or differential. In unipolar ranges, the output coding is straight binary.

The designed code transitions occur midway between successive integer LSB values, that is, 1/2 LSB and 3/2 LSB. The LSB size is FSR/65,536 for the AD7606C-16. The ideal transfer characteristics for the AD7606C-16 are shown in [Figure 82](#). The LSB size is dependent on the analog input range selected, as shown in [Table 11](#) and [Table 12](#).

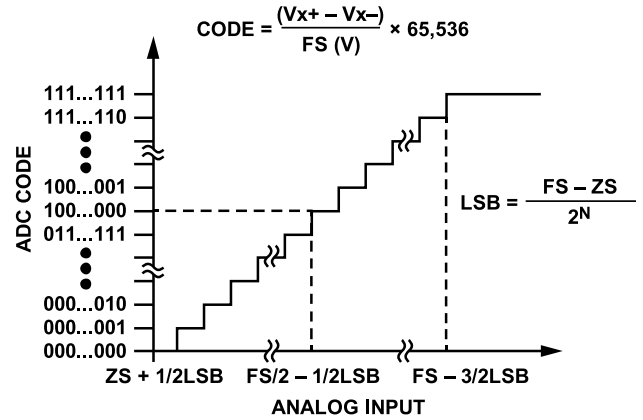

Figure 83. AD7606C-16 Ideal Transfer Characteristics, Unipolar Analog Input Ranges (Straight Binary Output Coding)

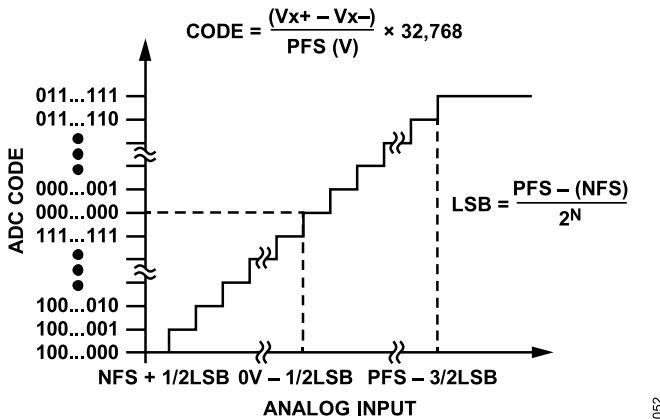

Figure 82. AD7606C-16 Ideal Transfer Characteristics, Bipolar Analog Input Ranges (Twos Complement Output Coding)

Table 11. Bipolar Input Voltage Ranges

Range (V)	PFS (V)	Midscale (V)	NFS (V)	LSB ( $\mu$ V)
Differential, Bipolar				
±20	+20	0	-20	610.35
±12.5	+12.5	0	-12.5	381.5
±10	+10	0	-10	305.2
±5	+5	0	-5	152.6
Single-Ended, Bipolar				
±12.5	+12.5	0	-12.5	381.5
±10	+10	0	-10	305.2
±6.25	+6.25	0	-6.25	190.7

## THEORY OF OPERATION

Table 11. Bipolar Input Voltage Ranges (Continued)

Range (V)	PFS (V)	Midscale (V)	NFS (V)	LSB ( $\mu$ V)
$\pm 5$	+5	0	-5	152.6
$\pm 2.5$	+2.5	0	-2.5	76.3

Table 12. Unipolar Input Voltage Ranges

Range (V)	PFS (V)	Midscale (V)	ZS (V)	LSB ( $\mu$ V)
Single-Ended, Unipolar				
0 to 12.5	12.5	6.25	0	190.7
0 to 10	10	5	0	152.6
0 to 5	5	2.5	0	76.3

## THEORY OF OPERATION

## REFERENCE

The AD7606C-16 contains an on-chip, 2.5 V, band gap reference. The REF $\overline{\text{IN}}$ /REF $\overline{\text{OUT}}$  pin allows the following:

- ▶ Access to the internal 2.5 V reference if the REF SELECT pin is tied to logic high
- ▶ Application of an external reference of 2.5 V if the REF SELECT pin is tied to logic low

Table 13. Reference Configuration

REF SELECT Pin	Reference Selected
Logic High	Internal reference enabled
Logic Low	Internal reference disabled; an external 2.5 V reference voltage must be applied to the REF $\overline{\text{IN}}$ /REF $\overline{\text{OUT}}$ pin

The AD7606C-16 contains a reference buffer configured to amplify the reference voltage up to approximately 4.4 V, as shown in Figure 84. The 4.4 V buffered reference is the reference used by the SAR ADC, as shown in Figure 84. After a reset, the AD7606C-16 operates in the reference mode selected by the REF SELECT pin. The REFCAPA and REFCAPB pins must be shorted together externally, and a ceramic capacitor of 10  $\mu\text{F}$  must be applied to the REF $\overline{\text{GND}}$  pin to ensure that the reference buffer is in closed-loop operation. A 0.1  $\mu\text{F}$  ceramic capacitor is required on the REF $\overline{\text{IN}}$ /REF $\overline{\text{OUT}}$  pin.

When the AD7606C-16 is configured in external reference mode, the REF $\overline{\text{IN}}$ /REF $\overline{\text{OUT}}$  pin is a high input impedance pin.

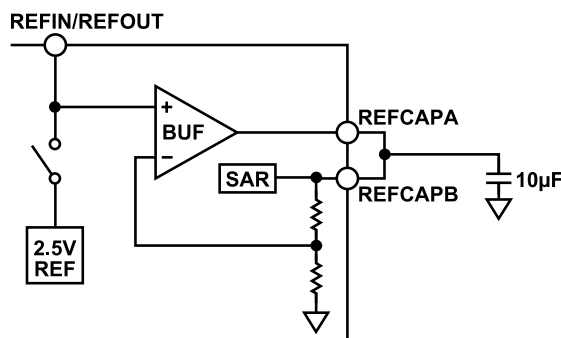

Figure 84. Reference Circuitry

## Using Multiple AD7606C-16 Devices

For applications using multiple AD7606C-16 devices, the configurations in the External Reference Mode section and the Internal Reference Mode section are recommended, depending on the application requirements.

## Internal Reference Mode

One AD7606C-16 device, configured to operate in internal reference mode, can drive the remaining AD7606C-16 devices, which are configured to operate in external reference mode (see Figure

85). Decouple the REF $\overline{\text{IN}}$ /REF $\overline{\text{OUT}}$  pin of the AD7606C-16, configured in internal reference mode, using a 10  $\mu\text{F}$  ceramic decoupling capacitor. The other AD7606C-16 devices, configured in external reference mode, must use at least a 100 nF decoupling capacitor on their REF $\overline{\text{IN}}$ /REF $\overline{\text{OUT}}$  pins.

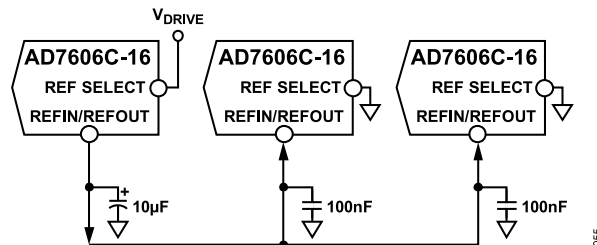
Figure 85. Internal Reference Driving Multiple AD7606C-16 REF $\overline{\text{OUT}}$  Pins

## External Reference Mode

One external reference can drive the REF $\overline{\text{IN}}$ /REF $\overline{\text{OUT}}$  pins of all AD7606C-16 devices (see Figure 86). In this configuration, decouple each REF $\overline{\text{IN}}$ /REF $\overline{\text{OUT}}$  pin of the AD7606C-16 with at least a 100 nF decoupling capacitor.

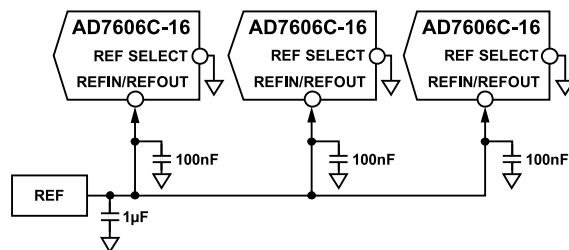
Figure 86. Single External Reference Driving Multiple AD7606C-16 REF $\overline{\text{OUT}}$  Pins

## OPERATION MODES

The AD7606C-16 can be operated in hardware or software mode by controlling the OS $\overline{\text{x}}$  pins, described in Table 14.

In hardware mode, the AD7606C-16 is configured depending on the logic level on the RANGE, OS $\overline{\text{x}}$ , or  $\overline{\text{STBY}}$  pins. The AD7606C-16 is backwards compatible to the AD7606, AD7606B, AD7608, and AD7609.

In software mode, that is, when all three OS $\overline{\text{x}}$  pins are connected to logic high level, the AD7606C-16 is configured by the corresponding registers accessed through the serial or parallel interface. Additional features are available, as described in Table 15.

The reference and the data interface is selected using the REF SELECT and  $\overline{\text{PAR}}$ /SER SEL pins, in both hardware and software modes.

## THEORY OF OPERATION

Table 14. Oversampling Pin Decoding

OS2	OS1	OS0	Oversampling Ratio
0	0	0	No oversampling
0	0	1	2
0	1	0	4
0	1	1	8
1	0	0	16
1	0	1	32
1	1	0	64
1	1	1	Enters software mode

Table 15. Functionality Matrix

Parameter	Hardware Mode	Software Mode
Analog Input Range <sup>1</sup>	$\pm 10$ V or $\pm 5$ V <sup>2</sup>	Single-ended, bipolar: $\pm 12.5$ V, $\pm 10$ V, $\pm 6.25$ V, $\pm 5$ V, and $\pm 2.5$ V <sup>3</sup> Single-ended, unipolar: 0 V to 12.5 V, 0 V to 10 V, 0 V to 5 V <sup>3</sup> Differential, bipolar: $\pm 20$ V, $\pm 12.5$ V, $\pm 10$ V, and $\pm 5$ V <sup>3</sup>
System Gain, Phase, and Offset Calibration	Not accessible	Available
OSR	From no OS to OSR = 64	From no OS to OSR = 256
Analog Input Open Circuit Detection	Not accessible	Available
Serial Data Output Lines	2	Selectable: 1, 2, or 8
Diagnostics	Not accessible	Available <sup>3</sup>
Power-Down Modes	Standby and shutdown	Standby, shutdown, and autostandby

<sup>1</sup> See Table 10 for the analog input range selection.

<sup>2</sup> Same input range configured in all input channels.

<sup>3</sup> On a per channel basis.

## Reset Functionality

The AD7606C-16 has two reset modes: partial or full. The reset mode selected is dependent on the length of the reset high pulse. A partial reset requires the RESET pin to be held high between 55 ns and 2  $\mu$ s. After 50 ns from the release of the RESET pin ( $t_{\text{DEVICE\_SETUP}}$ , partial reset), the device is fully functional and a conversion can be initiated. A full reset requires the RESET pin to be held high for a minimum of 3.2  $\mu$ s. After 274  $\mu$ s ( $t_{\text{DEVICE\_SETUP}}$ , full reset) from the release of the RESET pin, the device is completely reconfigured and a conversion can be initiated.

A partial reset reinitializes the following modules:

- ▶ Digital filter
- ▶ Serial peripheral interface (SPI) and parallel, resetting to ADC read mode
- ▶ SAR ADCs
- ▶ CRC logic

After the partial reset, the RESET\_DETECT bit of the status register asserts (Address 0x01, Bit 7). The current conversion result is discarded after the completion of a partial reset. The partial reset does not affect the register values programmed in software mode or the latches that store the user configuration in both hardware and software modes.

A full reset returns the device to the default power-on state, the RESET\_DETECT bit of the status register asserts (Address 0x01, Bit 7), and the current conversion result is discarded. The following features, in addition to the features that reinitialized with a partial reset and listed previously, are configured when the AD7606C-16 is released from full reset:

- ▶ Hardware mode or software mode
- ▶ Interface type (serial or parallel)

## Power-Down Modes

In hardware mode, two power-down modes are available on the AD7606C-16: standby mode and shutdown mode. The STBY pin controls whether the AD7606C-16 is in normal mode or in one of the two power-down modes, as shown in Table 16. If the STBY pin is low, the power-down mode is selected by the state of the RANGE pin.

Table 16. Power-Down Mode Selection, Hardware Mode

Power Mode	STBY Pin	RANGE Pin
Normal Mode	1	X <sup>1</sup>
Standby	0	1

## THEORY OF OPERATION

**Table 16. Power-Down Mode Selection, Hardware Mode (Continued)**

Power Mode	STBY Pin	RANGE Pin
Shutdown	0	0

<sup>1</sup> X means don't care.

In software mode, the power-down mode is selected through the OPERATION\_MODE bits on the CONFIG register (Address 0x02, Bits[1:0]) within the memory map. There is an extra power-down mode available in software mode called autostandby mode.

**Table 17. Power-Down Mode Selection, Software Mode, Through CONFIG Register (Address 0x02)**

Operation Mode	Address 0x02, Bit 1	Address 0x02, Bit 0
Normal	0	0
Standby	0	1
Autostandby	1	0
Shutdown	1	1

When the AD7606C-16 is placed in shutdown mode, all circuitry is powered down and the current consumption reduces to 4.5  $\mu$ A, maximum. A reset pulse is needed to exit shutdown mode. The power-up time is approximately 10 ms. When the AD7606C-16 is

powered up from shutdown mode, a full reset must be applied to the AD7606C-16 after the required power-up time elapses.

When the AD7606C-16 is placed in standby mode, all the PGAs and all the SAR ADCs enter a low power mode, such that the overall current consumption reduces to 6.5 mA, maximum. No reset is required after exiting standby mode.

When the AD7606C-16 is placed in autostandby mode, available only in software mode, the device automatically enters standby mode on the BUSY signal falling edge. The AD7606C-16 exits standby mode automatically on the CONVST signal falling edge. Therefore, the CONVST signal low pulse time is longer than  $t_{WAKE\_UP}$  (standby mode) = 1  $\mu$ s (see Figure 87).

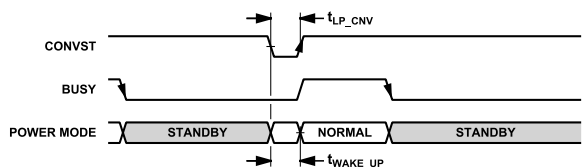
**Figure 87. Autostandby Mode Operation**

## DIGITAL FILTER

The AD7606C-16 contains an optional digital averaging filter that can be enabled in slower throughput rate applications that require higher SNR or dynamic range.

In hardware mode, the oversampling ratio of the digital filter is controlled using the oversampling pins, OS<sub>x</sub>, as shown in Table 14. The OS<sub>x</sub> pins are latched on the falling edge of the BUSY signal or upon a full reset.

In software mode, that is, if all OS<sub>x</sub> pins are tied to logic high, the oversampling ratio is selected through the oversampling register (Address 0x08). Two additional oversampling ratios (OS × 128 and OS × 256) are available in software mode.

In oversampling mode, the ADC takes the first sample for each channel on the rising edge of the CONVST signal. After converting the first sample, the subsequent samples are taken by the internally generated sampling signal, as shown in Figure 88. Alternatively, this sampling signal can be applied externally as described in the External Oversampling Clock section. For example, if oversampling by eight is configured, eight samples are taken, averaged, and the result is provided on the output. A CONVST signal rising edge triggers the first sample, and the remaining seven samples are taken with an internally generated sampling signal. Consequently, turning on the averaging of multiple samples leads to an improvement in SNR performance, at the expense of reducing the maximum throughput rate. When the oversampling function is turned on, the BUSY signal high time ( $t_{CONV}$ ) extends, as shown in Table 3.

Table 18 and Table 19 show the trade-off in SNR vs. bandwidth and throughput for the ±10 V single-ended range, ±20 V differential range, and 0 V to 10 V single-ended range. For other ranges, check the Design Tool in Tools & Simulations section of the product page.

Figure 88 shows that the conversion time ( $t_{CONV}$ ) extends when oversampling is turned on. The throughput rate ( $1/t_{CYCLE}$ ) must be reduced to accommodate the longer conversion time and to allow the read operation to occur. To achieve the fastest throughput rate possible when oversampling is turned on, the read can be performed during the BUSY signal high time as explained in the Reading During Conversion section.

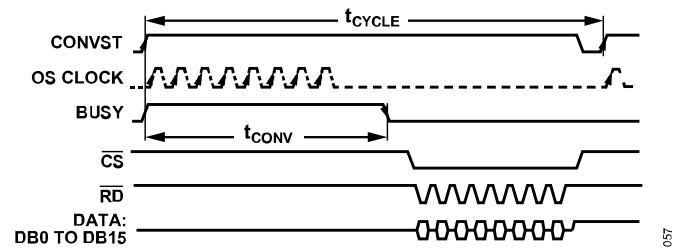

Figure 88. AD7606C-16 Oversampling by 8 Example, Read After Conversion, Parallel Interface, OS Clock Internally Generated Sampling Signal

Table 18. Oversampling Performance, Low Bandwidth Mode

Oversampling Ratio	Input Frequency (Hz)	±10 V Single-Ended Range		±20 V Differential Range		0 V to 10 V Single-Ended Range		Maximum Throughput (kSPS)
		SNR (dB)	-3 dB BW (kHz)	SNR (dB)	-3 dB BW (kHz)	SNR (dB)	-3 dB BW (kHz)	
No OS	1000	91.5	25	92	25	89	25	1000
2	1000	92.5	24.6	93	24.4	90	24.6	500
4	1000	94.5	24	95	23.7	91	24	250
8	1000	95	22.3	96	22.2	91.7	22.3	125
16	1000	96	17.8	96.5	17.6	92.5	17.8	62.5
32	160	96.5	11.6	97	11.5	93	11.6	31.25
64	160	97	6.5	97.5	6.4	94.5	6.4	15.6
128	50	97.5	3.3	97.6	3.4	95	3.3	7.8
256	50	97.7	1.7	97.8	1.7	95.5	1.7	3.9

Table 19. Oversampling Performance, High Bandwidth Mode

Oversampling Ratio	Input Frequency (Hz)	±10 V Single-Ended Range		±20 V Differential Range		0 V to 10 V Single-Ended Range		Maximum Throughput (kSPS)
		SNR (dB)	-3 dB BW (kHz)	SNR (dB)	-3 dB BW (kHz)	SNR (dB)	-3 dB BW (kHz)	
No OS	1000	86	220	88	220	81	220	1000
2	1000	89	154	91	154	84	155	500
4	1000	91	97.5	93	97.5	86.5	97.5	250
8	1000	92.5	53	94.5	53	88.5	53.5	125
16	1000	95	27.5	96	27.5	90.5	27.5	62.5
32	160	96	13.8	97	13.7	92	13.8	31.25
64	160	97	7	97.5	7	93.5	7	15.6
128	50	97.5	3.5	97.7	3.5	94.5	3.5	7.8

DIGITAL FILTER

Table 19. Oversampling Performance, High Bandwidth Mode (Continued)

Oversampling Ratio	Input Frequency (Hz)	±10 V Single-Ended Range		±20 V Differential Range		0 V to 10 V Single-Ended Range		Maximum Throughput (kSPS)
		SNR (dB)	-3 dB BW (kHz)	SNR (dB)	-3 dB BW (kHz)	SNR (dB)	-3 dB BW (kHz)	
256	50	97.7	1.7	97.8	1.7	95	1.7	3.9

PADDING OVERSAMPLING

As shown in Figure 88, an internally generated clock triggers the samples to be averaged, and then the ADC remains idle until the following CONVST signal rising edge. In software mode, through the oversampling register (Address 0x08), the internal clock (OS clock) frequency can be changed such that idle time is minimized, that is, sampling instants are equally spaced, as shown in Figure 89. As a result, the actual oversampling clock frequency depends on the OS\_PAD bits configuration, as per the following equation:

$$OS\_CLOCK(kHz) = \frac{1}{1000 \times \left(1 + \frac{OS\_PAD}{16}\right)} \tag{5}$$

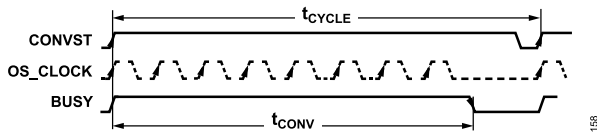

Figure 89. Oversampling by 8 Example, Oversampling Padding Enabled

EXTERNAL OVERSAMPLING CLOCK

In software mode, there is an option to apply an external clock through the CONVST pin when oversampling mode is enabled. Providing a low jitter external clock improves SNR performance for large oversampling ratios. By applying an external clock, the input is sampled at regular time intervals, which is optimum for antialiasing performance.

To enable the external oversampling clock, Bit 5 in the CONFIG register (Address 0x02, Bit 5) must be set. Then, the throughput rate is the following:

$$Throughput = \frac{1}{t_{CONVST} \times OSR} \tag{6}$$

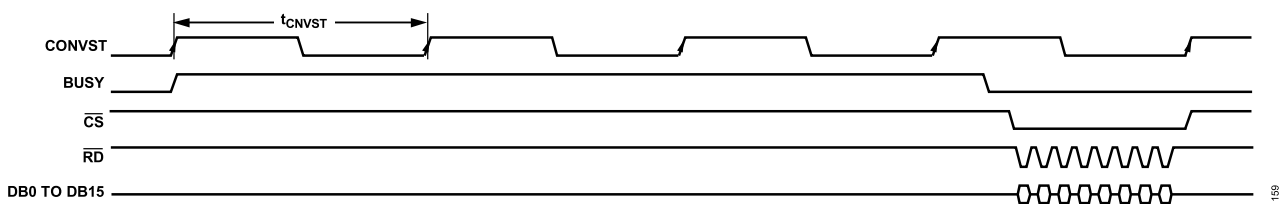

Figure 91. External OS Clock Applied on the CONVST Pin (OSR = 4), Parallel Interface

That is, the sampling signal is provided externally through the CONVST pin, and every OSR number of clocks, an output is averaged and provided, as shown in Figure 91. This feature is available using either the parallel interface or the serial interface.

Simultaneous Sampling of Multiple AD7606C-16 Devices

In general, synchronizing several SAR ADCs can easily be achieved by using a common CONVST signal. However, when OS is enabled, an internal clock is used by default to trigger the subsequent samples. Any deviation between these internal clocks may impede device-to-device synchronization. This deviation can be minimized by using external OS because the CONVST signal of all the samples are managed externally.

A partial reset ( $t_{RESET} < 2 \mu s$ ) interrupts the oversampling process and empties the data register. Therefore, if by any reason one of the AD7606C-16 devices is not in synchrony, issuing a partial reset easily resynchronizes them all, as shown in Figure 90.

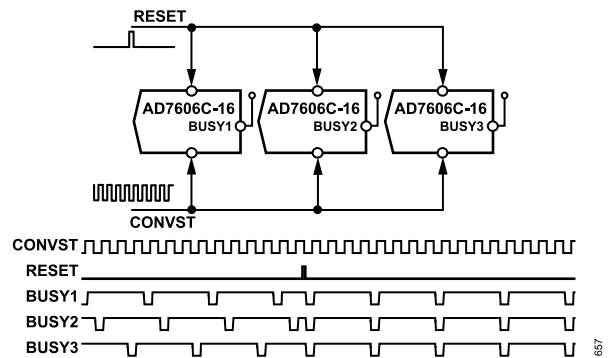

Figure 90. Synchronizing Multiple AD7606C-16 Devices with External OS Clock Enabled

**SYSTEM CALIBRATION FEATURES**

The following system calibration features are available in software mode by writing to corresponding registers in the memory map:

- ▶ Phase calibration
- ▶ Gain calibration
- ▶ Offset calibration
- ▶ Analog input open circuit detection

**SYSTEM PHASE CALIBRATION**

When using an external filter, as shown in Figure 93, any mismatch on the discrete components, or in the sensor being used, can cause phase mismatch between channels. This phase mismatch can be compensated for in software mode, on a per channel basis, by delaying the sampling instant on individual channels.

The sampling instant on any particular channel can be delayed with regard to the CONVST signal rising edge, with a resolution of 1  $\mu$ s, and up to 255  $\mu$ s, by writing to the corresponding CHx\_PHASE register (Address 0x19 through Address 0x20).

For example, if the CH4\_PHASE register (Address 0x1C) is written with 10 (decimal), Channel 4 is effectively sampled 10  $\mu$ s ( $t_{PHASE\_REG}$ ) after the CONVST signal rising edge, as shown in Figure 92.

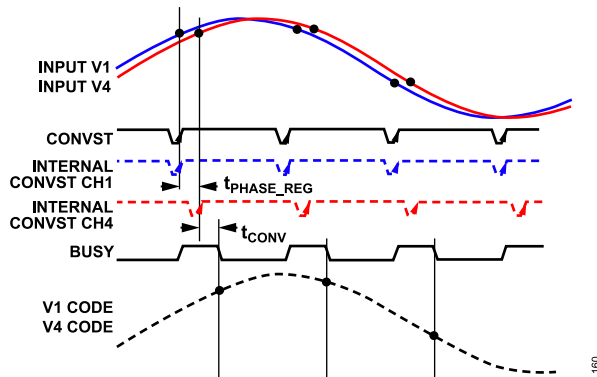

Figure 92. System Phase Calibration Functionality

Note that delaying any channel extends the BUSY signal high time, and  $t_{CONV} = n + 1 \mu$ s, with n as the CHx\_PHASE register content of the most delayed channel.

In the previously explained example and Figure 92, if only the CH4\_PHASE register is programmed,  $t_{CONV}$  increases by 11  $\mu$ s. Therefore, this scenario must be considered when running at higher throughput rates.

**SYSTEM GAIN CALIBRATION**

Using an external  $R_{FILTER}$ , as shown in Figure 93, generates a system gain error. This gain error can be compensated for in software mode, on a per channel basis, by writing the series resistor value used on the corresponding register, Address 0x09 through Address 0x10. These registers can compensate up to 65 k $\Omega$  series resistors, with a resolution of 1024  $\Omega$ .

Note that system gain calibration is only available on bipolar analog input ranges, both single-ended and differential. System gain calibration is not available in unipolar single-ended ranges.

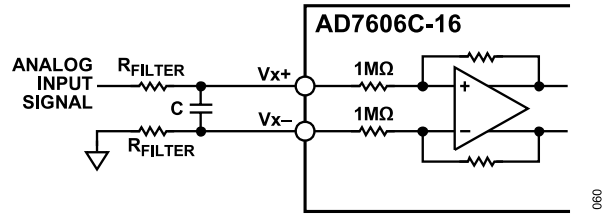

Figure 93. System Gain Error

For example, if a 27 k $\Omega$  resistor is placed in series to the analog input of Channel 5, the resistor generates a -2% positive full-scale error on the system (at  $\pm 10$  V range), as shown in Figure 94. In software mode, this error is eliminated by writing 27 (decimal) to the CH5\_GAIN register (Address 0x0D), which keeps the error within 0.05% of FSR, no matter the  $R_{FILTER}$  value of the series resistor, as shown in Figure 95.

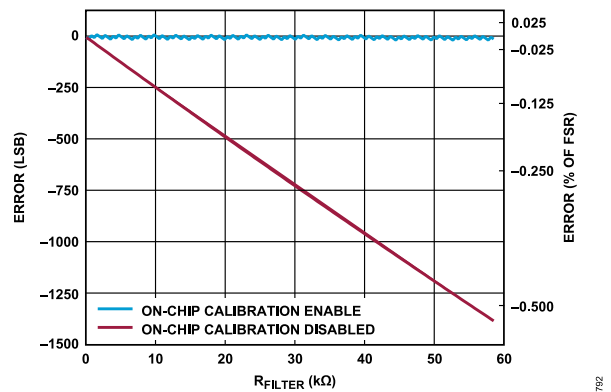

Figure 94. System Gain Calibration with and Without Calibration,  $\pm 10$  V Single-Ended Range

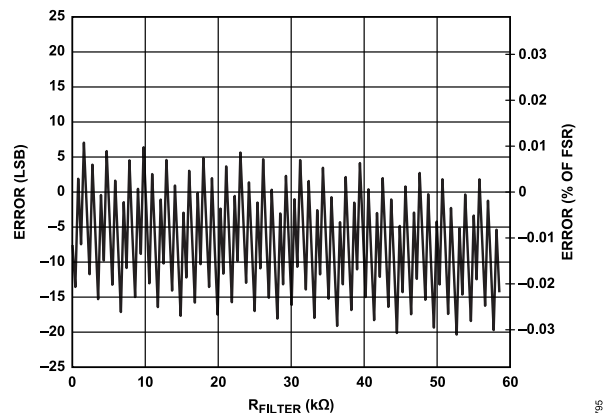

Figure 95. System Error with Gain Calibration Enabled



SYSTEM CALIBRATION FEATURES

SYSTEM OFFSET CALIBRATION

A potential offset on the sensor, or any offset caused by a mismatch between the  $R_{FILTER}$  pair placed on a particular channel (as described in the [Analog Front End](#) section), can be compensated in software mode, on a per channel basis. The  $CHx\_OFFSET$  registers (Address 0x11 through Address 0x18) allow the ability to add or subtract up to 128 LSBs from the ADC code automatically, with a resolution of 1 LSB, as shown in [Table 20](#).

For example, if the signal connected to Channel 3 has a 9 mV offset, and the analog input range is set to the  $\pm 10$  V range (where LSB size = 305  $\mu$ V) to compensate for this offset, program -30 LSB to the corresponding register. Writing 128 (decimal) - 30 (decimal) = 0x80 - 0x1E = 0x62 to the  $CH3\_OFFSET$  register (Address 0x13) removes such offset.

Table 20.  $CHx\_OFFSET$  Register Bit Decoding

$CHx\_OFFSET$ Register	Offset Calibration (LSB)
0x00	-128
0x45	-59
0x80 (Default)	0
0x83	+3
0xFF	+127

ANALOG INPUT OPEN CIRCUIT DETECTION

The AD7606C-16 has an analog input open circuit detection feature available in software mode. To use this feature,  $R_{PD}$  must be placed as shown in [Figure 96](#). If the analog input is disconnected, for example, if a switch opens in [Figure 96](#), the source impedance changes from the burden resistor ( $R_{BURDEN}$ ) to  $R_{PD}$ , as long as  $R_{BURDEN} < R_{PD}$ . It is recommended to use  $R_{PD} = 20$  k $\Omega$  so that the AD7606C-16 can detect changes in the source impedance by internally switching the PGA common-mode voltage. Analog input open circuit detection operates in manual mode or in automatic mode.

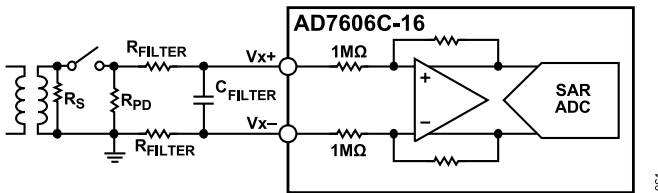

Figure 96. Analog Front End with  $R_{PD}$

Note that analog input open circuit detection is only available on bipolar single-ended input ranges. Analog input open circuit detection is neither available in unipolar single-ended nor in differential ranges.

Manual Mode

In manual mode, enabled by writing 0x01 to  $OPEN\_DETECT\_QUEUE$  (Address 0x2C), each PGA common-mode voltage is controlled by the corresponding  $CHx\_OPEN\_DETECT\_EN$  bit on the  $OPEN\_DETECT\_ENABLE$  register (Address 0x23). Setting this bit high shifts up the PGA common-mode voltage. If there is an open circuit on the analog input, the ADC output changes proportionally to the  $R_{PD}$  resistor, as shown in [Figure 97](#). If there is no open circuit, any change on the PGA common-mode voltage has no effect on the ADC output.

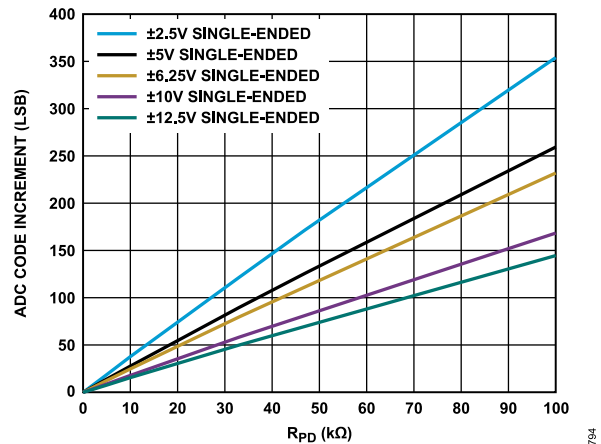

Figure 97. Open Circuit Code Error Increment, Dependent of  $R_{PD}$

Automatic Mode

Automatic mode is enabled by writing any value greater than 0x01 to the  $OPEN\_DETECT\_QUEUE$  register (Address 0x2C), as shown in [Table 21](#). If the AD7606C-16 detects that the ADC reported a number (specified in the  $OPEN\_DETECT\_QUEUE$  register) of consecutive unchanged conversions, the analog input open circuit detection algorithm is performed internally and automatically. The analog input open circuit detection algorithm automatically changes the PGA common-mode voltage, checks the ADC output, and returns to the initial common-mode voltage, as shown in [Figure 98](#). If the ADC code changes in any channel with the PGA common-mode change, this implies that there is no input signal connected to that analog input, and the corresponding flag asserts within the  $OPEN\_DETECTED$  register (Address 0x24). Each channel can be individually enabled or disabled through the  $OPEN\_DETECT\_ENABLE$  register (Address 0x23).

SYSTEM CALIBRATION FEATURES

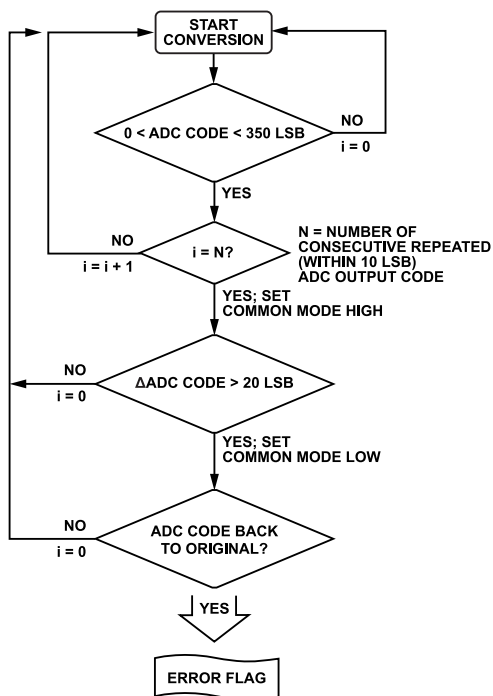

Figure 98. Automatic Analog Input Open Circuit Detect Flowchart

Table 21. Analog Input Open Circuit Detect Mode Selection and Register Functionality

OPEN_DETECT_QUEUE (Address 0x2C)	Open Detect Mode	OPEN_DETECT_ENABLE (Address 0x23)
0x00 (Default)	Disabled	Not applicable
0x01	Manual	Sets common-mode voltage high or low, on a per channel basis
0x02 <sup>1</sup> to 0xFF	Automatic; OPEN_DETECT_QUEUE is the number of consecutive conversions before asserting any CHx_OPEN flag.	Enables or disables automatic analog input open circuit detection on a per channel basis

<sup>1</sup> It is recommended to write to OPEN\_DETECT\_QUEUE a value greater than 5.

If no oversampling is used, the recommended minimum number of conversions to be programmed for the AD7606C-16 to automatically detect an open circuit on the analog input is

$$OPEN\_DETECT\_QUEUE = 10 \times f_{SAMPLE}(R_{PD} + 2 \times R_{FILTER}) \times (C_{FILTER} + 10pF) \tag{7}$$

However, when oversampling mode is enabled, the recommended minimum number of conversions to use is

$$OPEN\_DETECT\_QUEUE = 10 \times f_{SAMPLE} \times 2(R_{PD} + 2 \times R_{FILTER}) \times (C_{FILTER} + 10pF) \times OSR \tag{8}$$

## DIGITAL INTERFACE

The AD7606C-16 provides two interface options: a parallel interface and a high speed serial interface. The required interface mode is selected through the  $\overline{\text{PAR}}/\text{SER SEL}$  pin.

**Table 22. Interface Mode Selection**

$\overline{\text{PAR}}/\text{SER SEL}$	Interface Mode
0	Parallel
1	Serial

Operation of the interface modes is discussed in the [Hardware Mode](#) section and the [Software Mode](#) section.

### HARDWARE MODE

In hardware mode, only ADC read mode is available. ADC data can be read from the AD7606C-16 through the parallel data bus with standard  $\overline{\text{CS}}$  and  $\overline{\text{RD}}$  signals or through the serial interface with standard  $\overline{\text{CS}}$ , SCLK, and two  $\text{D}_{\text{OUTX}}$  signals.

See the [Reading Conversion Results \(Parallel ADC Read Mode\)](#) section and the [Reading Conversion Results \(Serial ADC Read Mode\)](#) section for more details on how ADC read mode operates.

**Table 23. Data Interface Pin Function per Mode of Operation**

Pin Mnemonic	Pin No.	Parallel Interface			Serial Interface		
		Hardware Mode	Software Mode		Hardware Mode	Software mode	
			ADC Mode	Register Mode		ADC Mode	Register mode
DB0 to DB2	16 to 18	DB0 to DB2	Register data	N/A <sup>1</sup>		N/A	
DB3/ $\text{D}_{\text{OUTE}}$	19	DB3	Register data	N/A	$\text{D}_{\text{OUTE}}^2$	Unused	
DB4/ $\text{D}_{\text{OUTF}}$	20	DB4	Register data	N/A	$\text{D}_{\text{OUTF}}^2$	Unused	
DB5/ $\text{D}_{\text{OUTG}}$	21	DB5	Register data	N/A	$\text{D}_{\text{OUTG}}^2$	Unused	
DB6/ $\text{D}_{\text{OUTH}}$	22	DB6	Register data	N/A	$\text{D}_{\text{OUTH}}^2$	Unused	
DB7/ $\text{D}_{\text{OUTA}}$	24	DB7	Register data (MSB)	$\text{D}_{\text{OUTA}}$	$\text{D}_{\text{OUTA}}$	$\text{D}_{\text{OUTA}}$	
DB8/ $\text{D}_{\text{OUTB}}$	25	DB8	ADD0	$\text{D}_{\text{OUTB}}$	$\text{D}_{\text{OUTB}}^3$	Unused	
DB9/ $\text{D}_{\text{OUTC}}$	27	DB9	ADD1	N/A	$\text{D}_{\text{OUTC}}^4$	Unused	
DB10/ $\text{D}_{\text{OUTD}}$	28	DB10	ADD2	N/A	$\text{D}_{\text{OUTD}}^4$	Unused	
DB11/SDI	29	DB11	ADD3	N/A	Unused	SDI	
DB12	30	DB12	ADD4		N/A		
DB13	31	DB13	ADD5		N/A		
DB14	32	DB14	ADD6		N/A		
DB15	33	DB15	$\text{R}\overline{\text{W}}$		N/A		

<sup>1</sup> N/A means not applicable. Tie all N/A pins to AGND.

<sup>2</sup> Only used if 8  $\text{D}_{\text{OUTX}}$  mode is selected on the CONFIG register, otherwise leave unconnected.

<sup>3</sup> Only used if 2  $\text{D}_{\text{OUTX}}$ , 4  $\text{D}_{\text{OUTX}}$ , or 8  $\text{D}_{\text{OUTX}}$  mode is selected on the CONFIG register, otherwise leave unconnected.

<sup>4</sup> Only used if 4  $\text{D}_{\text{OUTX}}$  or 8  $\text{D}_{\text{OUTX}}$  mode is selected on the CONFIG register, otherwise leave unconnected

### SOFTWARE MODE

In software mode, which is active only when all three OS pins are tied high, both ADC read mode and register mode are available. ADC data can be read from the AD7606C-16, and registers can also be read from and written to the AD7606C-16 through the parallel data bus with standard  $\overline{\text{CS}}$ ,  $\overline{\text{RD}}$ , and  $\overline{\text{WR}}$  signals or through the serial interface with standard  $\overline{\text{CS}}$ , SCLK, SDI, and  $\text{D}_{\text{OUTA}}$  lines.

See the [Parallel Register Mode \(Reading Register Data\)](#) section and the [Parallel Register Mode \(Writing Register Data\)](#) section for more details on how register mode operates.

Pin functions differ depending on the interface selected (parallel or serial) and the operation mode (hardware or software), as shown in [Table 23](#).

DIGITAL INTERFACE

PARALLEL INTERFACE

To read ADC data or to read and write the register content over the parallel interface, tie the  $\overline{\text{PAR/SER SEL}}$  pin low. The rising edge of the  $\overline{\text{CS}}$  input signal moves the bus into three-state, and the falling edge of the  $\overline{\text{CS}}$  input signal takes the bus out of the high impedance state.  $\overline{\text{CS}}$  is the control signal that enables the data lines and it is the function that allows multiple AD7606C-16 devices to share the same parallel data bus.

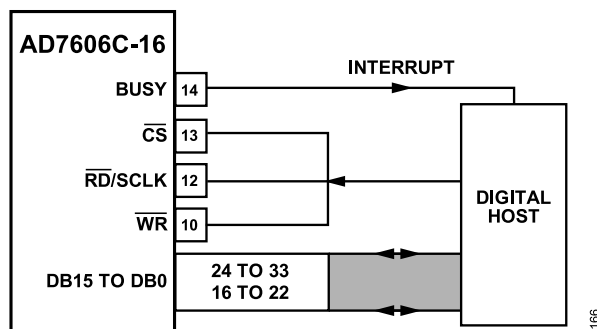

Figure 99. AD7606C-16 Interface Diagram—One AD7606C-16 Using the Parallel Bus, with  $\overline{\text{CS}}$  and  $\overline{\text{RD}}$  Shorted Together

Reading Conversion Results (Parallel ADC Read Mode)

The falling edge of the  $\overline{\text{RD}}$  pin reads data from the output conversion results register. Applying a sequence of  $\overline{\text{RD}}$  pulses to the  $\overline{\text{RD}}$

pin clocks the conversion results out from each channel to the parallel bus, Bits[DB15:DB0], in ascending order, from V1 to V8, as shown in Figure 100.

The  $\overline{\text{CS}}$  signal can be permanently tied low, and the  $\overline{\text{RD}}$  signal can access the conversion results, as shown in Figure 3. A read operation of new data can take place after the BUSY signal goes low (see Figure 2). Alternatively, a read operation of data from the previous conversion process can take place while the BUSY pin is high.

When there is only one AD7606C-16 in a system and it does not share the parallel bus, data can be read using one control signal from the digital host. The  $\overline{\text{CS}}$  and  $\overline{\text{RD}}$  signals can be tied together, as shown in Figure 4. In this case, the falling edge of the  $\overline{\text{CS}}$  and  $\overline{\text{RD}}$  signals bring the data bus out of three-state and clocks out the data.

The FRSTDATA output signal indicates when the first channel, V1, is being read back, as shown in Figure 4. When the  $\overline{\text{CS}}$  input is high, the FRSTDATA output pin is in three-state. The falling edge of  $\overline{\text{CS}}$  takes the FRSTDATA pin out of three-state. The falling edge of the  $\overline{\text{RD}}$  signal corresponding to the result of V1 sets the FRSTDATA pin high, indicating that the result from V1 is available on the output data bus. The FRSTDATA pin returns to a logic low following the next falling edge of  $\overline{\text{RD}}$ .

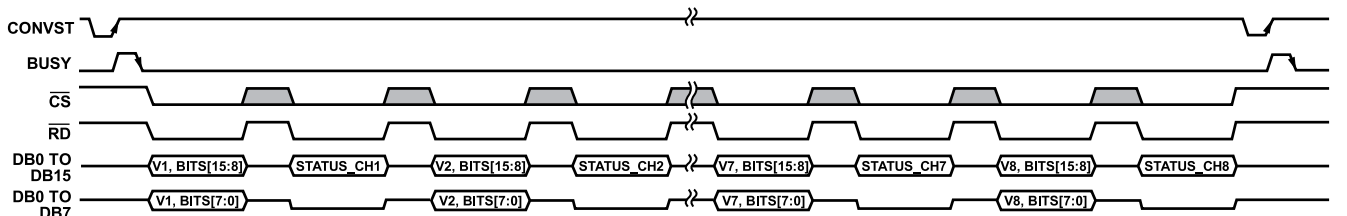

Figure 100. Parallel Interface, ADC Mode with Status Header Enabled

DIGITAL INTERFACE

Reading During Conversion

The data read operation from the AD7606C-16, as shown in Figure 101, can occur in the following scenarios:

- ▶ After conversion, such as when the BUSY line is low
- ▶ During conversion, such as when the BUSY line is high
- ▶ Start while the BUSY line is low and end while the following conversion, see Figure 2

Reading during conversion has little effect on the performance of the converter, and it allows a faster throughput rate to be achieved. Data can be read from the AD7606C-16 at any time other than on the falling edge of the BUSY signal because this falling edge is when the output data registers are updated with the new conversion data. Any data read while the BUSY signal is high must be completed before the falling edge of the BUSY signal.

Parallel ADC Read Mode with CRC Enabled

In software mode, the parallel interface supports reading the ADC data with the CRC appended, when enabled through the INT\_CRC\_ERR\_EN bit (Address 0x21, Bit 2). The CRC is 16 bits, and it is clocked out after reading all eight channel conversions, as shown in Figure 102. The CRC calculation includes all data on the DBx pins: data, status (when appended), and zeros. See the Diagnostics section for more details on the CRC.

Parallel ADC Read Mode with Status Enabled

In software mode, the 8-bit status header is enabled (see Table 25) by setting STATUS\_HEADER in the CONFIG register (Address 0x02, Bit 6), and each channel then takes two frames of data:

- ▶ The first frame clocks the ADC data out through DB15 to DB0.
- ▶ The second frame clocks out the status header of the channel on DB15 to DB8, DB15 being the MSB and DB8 being the LSB, while DB7 to DB0 clock out zeros.

This sequence is shown in Figure 100. Table 25 explains the status header content and describes each bit.

Table 24. CH.IDx Bits Decoding in Status Header

CH.ID2	CH.ID1	CH.ID0	Channel Number
0	0	0	Channel 1 (V1)
0	0	1	Channel 2 (V2)
0	1	0	Channel 3 (V3)
0	1	1	Channel 4 (V4)
1	0	0	Channel 5 (V5)
1	0	1	Channel 6 (V6)
1	1	0	Channel 7 (V7)
1	1	1	Channel 8 (V8)

Table 25. Status Header, Parallel Interface

Bit Details	Bit 7 (MSB)	Bit 6	Bit 5	Bit 4	Bit 3	Bit 2	Bit 1	Bit 0 (LSB)
Content	RESET_DETECT	DIGITAL_ERROR	OPEN_DETECTED	RESERVED	RESERVED	CH.ID2	CH.ID1	CH.ID0
Meaning <sup>1</sup>	Reset detected	Error flag on Address 0x22	The analog input of this channel is open	RESERVED	RESERVED	Channel ID (see Table 24)		

<sup>1</sup> See the Diagnostics section for more information.

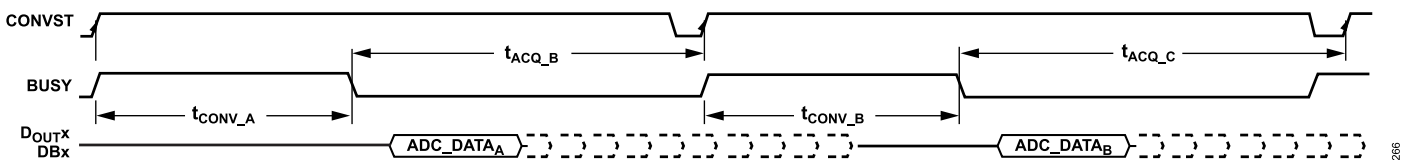

Figure 101. ADC Data Read Can Happen After Conversion and/or During the Following Conversion

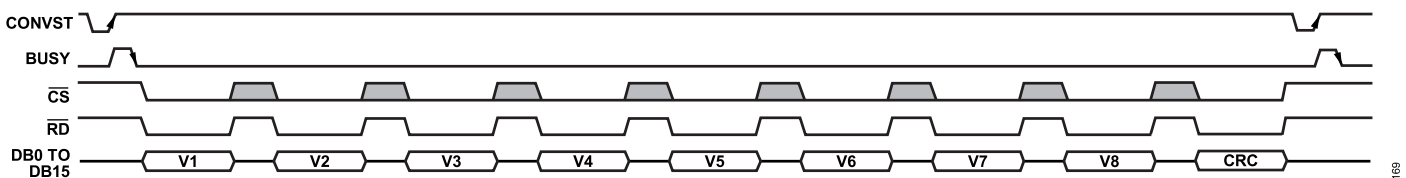

Figure 102. Parallel Interface, ADC Read Mode with CRC Enabled

## DIGITAL INTERFACE

**Parallel Register Mode (Reading Register Data)**

In software mode, all the registers in [Table 31](#) can be read over the parallel interface. Bits[DB15:DB0] leave a high impedance state when both the  $\overline{CS}$  signal and  $\overline{RD}$  signal are logic low for reading register content, or when both the  $\overline{CS}$  signal and  $\overline{WR}$  signal are logic low for writing register address and/or register content.

A register read is performed through two frames: first, a read command is sent to the AD7606C-16 and second, the AD7606C-16 clocks out the register content. The format for a register read command is shown in the leading two frames of [Figure 103](#). On the first frame, perform the following:

- ▶ Bit DB15 must be set to 1 to select a read command. The read command places the AD7606C-16 in register mode.
- ▶ Bits [DB14:DB8] must contain the register address.
- ▶ The subsequent eight bits, Bits[DB7:DB0], are ignored.

The register address is latched on the AD7606C-16 on the rising edge of the  $\overline{WR}$  signal. The register content can then be read from the latched register by bringing the  $\overline{RD}$  line low on the following frame, as follows:

- ▶ Bit DB15 is pulled to 0 by the AD7606C-16.
- ▶ Bits[DB14:DB8] provide the register address being read.
- ▶ The subsequent eight bits, Bits[DB7:DB0], provide the register content.

To revert to ADC read mode, keep all DBx pins low during one  $\overline{WR}$  cycle, as shown in the [Parallel Register Mode \(Writing Register Data\)](#) section. No ADC data can be read while the device is in register mode.

**Parallel Register Mode (Writing Register Data)**

In software mode, all the R/W registers in [Table 31](#) can be written to over the parallel interface. To write a sequence of registers, firstly exit ADC read mode (default mode) by reading any register on the memory map as explained in the [Parallel Register Mode \(Reading Register Data\)](#) section. A register write command is performed by a single frame, through the parallel bus (Bits[DB15:DB0]),  $\overline{CS}$  signal, and  $\overline{WR}$  signal. The format of a write command, as shown in [Figure 103](#), is structured as follows:

- ▶ Bit DB15 must be set to 0 to select a write command.
- ▶ Bits[DB14:DB8] contain the register address.
- ▶ The subsequent eight bits, Bits[DB7:DB0], contain the data to be written to the selected register.

Data is latched onto the device on the rising edge of the  $\overline{WR}$  pin. To revert to ADC read mode, keep all DBx pins low during one  $\overline{WR}$  cycle. No ADC data can be read while the device is in register mode.

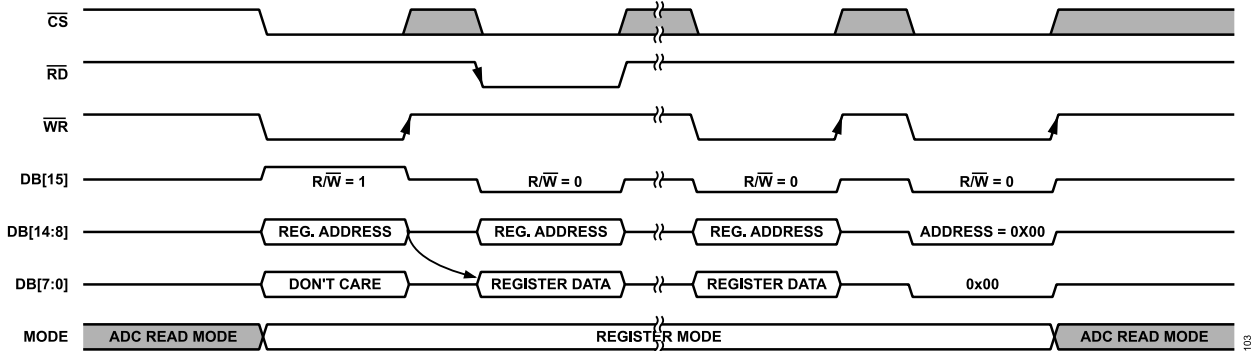

Figure 103. Parallel Interface Register Read Operation, Followed by a Write Operation

DIGITAL INTERFACE

SERIAL INTERFACE

To read ADC data or to read/write the content of the register over the serial interface, tie the  $\overline{\text{PAR/SER SEL}}$  pin high.

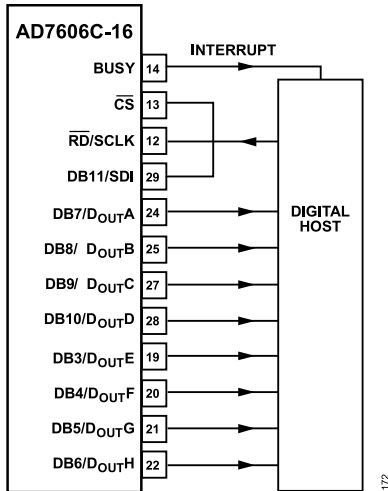

Figure 104. AD7606C-16 Interface Diagram—One AD7606C-16 Using the Serial Interface with Four  $D_{OUTX}$  Lines

Reading Conversion Results (Serial ADC Read Mode)

The AD7606C-16 has eight serial data output pins,  $D_{OUTA}$  to  $D_{OUTH}$ . In software mode, data can be read back from the AD7606C-16 using either one (see Figure 108), two (see Figure 105), four (see Figure 106), or eight  $D_{OUTX}$  lines (see Figure 107), depending on the configuration set in the CONFIG register.

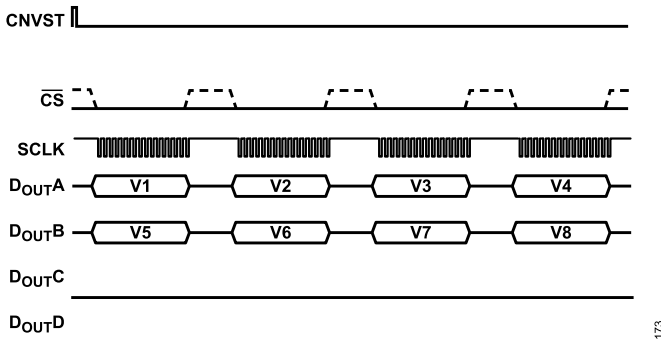

Figure 105. Serial Interface ADC Reading, Two  $D_{OUTX}$  Lines

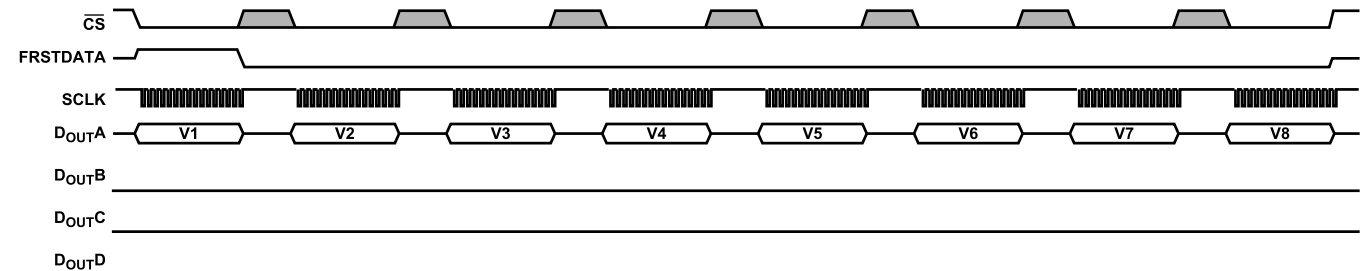

Figure 108. Serial Interface ADC Reading, One  $D_{OUTX}$  Lines

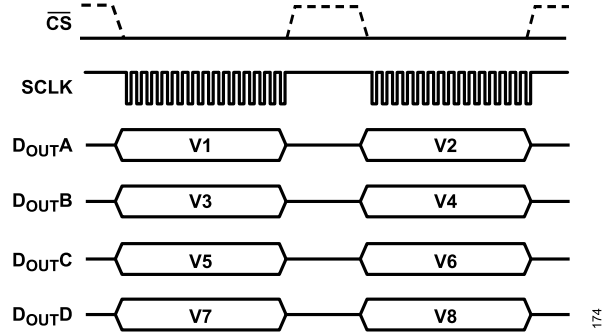

Figure 106. Serial Interface ADC Reading, Four  $D_{OUTX}$  Lines

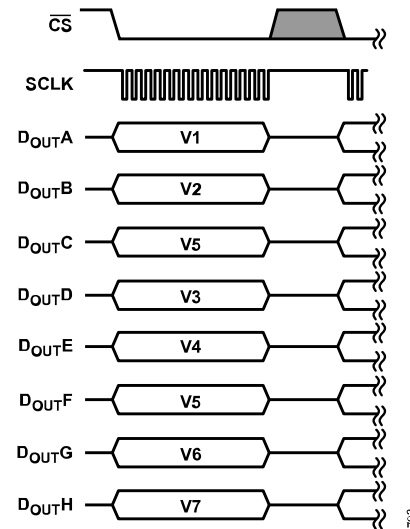

Figure 107. Serial Interface ADC Reading, Eight  $D_{OUTX}$  Lines

Table 26.  $D_{OUTX}$  Format Selection, Using the CONFIG Register (Address 0x02)

$D_{OUTX}$ Format	Address 0x02, Bit 4	Address 0x02, Bit 3
1 $D_{OUTX}$	0	0
2 $D_{OUTX}$	0	1
4 $D_{OUTX}$	1	0
8 $D_{OUTX}$	1	1

In hardware mode, only the 2  $D_{OUTX}$  lines option is available. However, all channels can be read from  $D_{OUTA}$  by providing eight 16-bit SPI frames between two CONVST pulses.

## DIGITAL INTERFACE

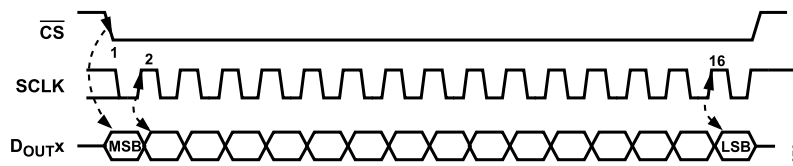

Figure 109. Serial Interface Data Read Back (One Channel)

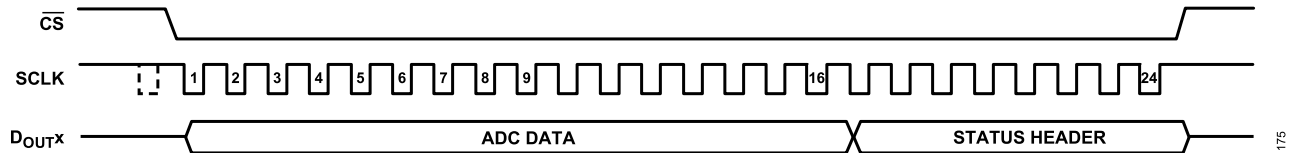

Figure 110. Serial Interface, ADC Mode

The  $\overline{CS}$  falling edge takes the data output lines,  $D_{OUTx}$ , out of three-state and clocks out the MSB of the conversion result, as shown in Figure 109.

In 3-wire mode ( $\overline{CS}$  tied low), instead of  $\overline{CS}$  clocking out the MSB, the falling edge of the  $BUSY$  signal clocks out the MSB. The rising edge of the  $SCLK$  signal clocks all the subsequent data bits on the serial data outputs,  $D_{OUTx}$ , as shown in Figure 6. The  $\overline{CS}$  input can be held low for the entire serial read operation, or it can be pulsed to frame each channel read of 16  $SCLK$  cycles (see Figure 105). However, if  $\overline{CS}$  is pulsed during a channel conversion result transmission before reaching the LSB, the channel that was interrupted retransmits on the next frame, completely starting again from the MSB.

Data can also be clocked out using only the  $D_{OUTA}$  line, as shown in Figure 108. For the AD7606C-16 to access all eight conversion results on one  $D_{OUTx}$  line, a total of 128  $SCLK$  cycles is required. In hardware mode, these 128  $SCLK$  cycles must be framed in groups of 16  $SCLK$  cycles by the  $\overline{CS}$  signal. The disadvantage of using just one  $D_{OUTx}$  line is that the throughput rate is reduced if reading occurs after conversion. Leave the unused  $D_{OUTx}$  lines unconnected in serial mode.

Figure 106 shows a read of eight simultaneous conversion results using four  $D_{OUTx}$  lines on the AD7606C-16, available in software mode. In this case, a 32  $SCLK$  transfer accesses data from the AD7606C-16, and  $\overline{CS}$  is either held low to frame the entire 32  $SCLK$  cycles or is pulsed between two 16-bit frames. This mode is only available in software mode, and it is configured using the  $CONFIG$  register (Address 0x02).

Figure 6 shows the timing diagram for reading one channel of data, framed by the  $\overline{CS}$  signal, from the AD7606C-16 in serial mode. The  $SCLK$  input signal provides the clock source for the serial read operation. The  $\overline{CS}$  signal goes low to access the data from the AD7606C-16.

The  $FRSTDATA$  output signal indicates when the first channel, V1, is being read back. When the  $\overline{CS}$  input is high, the  $FRSTDATA$  output pin is in three-state. In serial mode, the falling edge of the

$\overline{CS}$  signal takes the  $FRSTDATA$  pin out of three-state and sets the  $FRSTDATA$  pin high if the  $BUSY$  line is already deasserted, indicating that the result from V1 is available on the  $D_{OUTA}$  output data line. The  $FRSTDATA$  output returns to a logic low following the 16<sup>th</sup>  $SCLK$  falling edge. If the  $\overline{CS}$  pin is tied permanently low (3-wire mode), the falling edge of the  $BUSY$  line sets the  $FRSTDATA$  pin high when the result from V1 is available on  $D_{OUTA}$ .

If  $SDI$  is tied low or high, nothing is clocked to the AD7606C-16. Therefore, the device remains clocking out conversion results. When using the AD7606C-16 in 3-wire mode, keep  $SDI$  at a high level. While in ADC read mode, single-write operations can be performed, as shown in Figure 110. For writing a sequence of registers, switch to register mode, as described in the [Serial Register Mode \(Writing Register Data\)](#) section.

### Reading During Conversion—Serial Interface

The data read operation from the AD7606C-16, as shown in Figure 101, occurs in the following scenarios:

- ▶ After conversion, such as when the  $BUSY$  line is low
- ▶ During conversion, such as when the  $BUSY$  line is high
- ▶ Starts when the  $BUSY$  line is low and ends during the following conversion, see Figure 2.

Reading during conversion has little effect on the performance of the converter, and it allows a faster throughput rate to be achieved. Data can be read from the AD7606C-16 at any time other than on the falling edge of the  $BUSY$  signal because this falling edge is when the output data registers are updated with the new conversion data. Any data read while the  $BUSY$  signal is high must be completed before the falling edge of the  $BUSY$  signal.

### Serial ADC Read Mode with CRC Enabled

In software mode, the CRC can be enabled by writing to the register map. In this case, the CRC is appended on each  $D_{OUTx}$  line after the last channel is clocked out, as shown in Figure 116. See the [Interface CRC Checksum](#) section for more information on how the CRC is calculated.



DIGITAL INTERFACE

Serial ADC Read Mode with Status Enabled

In software mode, the 8-bit status header (see Table 27) can be turned on when using the serial interface so that it is appended after each 16-bit data conversion, extending the frame size to 24 bits per channel, as shown in Figure 110.

Serial Register Mode (Reading Register Data)

All the registers in Table 31 can be read over the serial interface. The format for a read command is shown in Figure 111. A read command consists of two 16-bit frames. On the first frame, perform the following:

- ▶ The first bit clocked in SDI must be set to 0 to enable writing the address.

- ▶ The second bit clocked in SDI must be set to 1 to select a read command.
- ▶ Bits[3:8] in SDI contain the register address to be clocked out on D<sub>OUTA</sub> on the following frame.
- ▶ The subsequent eight bits, Bits[9:16], clocked in SDI are ignored.

If the AD7606C-16 is in ADC read mode, the serial data out (SDO) keeps clocking ADC data on Bits[9:16], and then the AD7606C-16 switches to register mode.

If the AD7606C-16 is in register mode, the SDO reads back the content from the previous addressed register, no matter if the previous frame was a read or a write command. To exit register mode, keep the SDI line low for 16 SCLK cycles as shown in Figure 112.

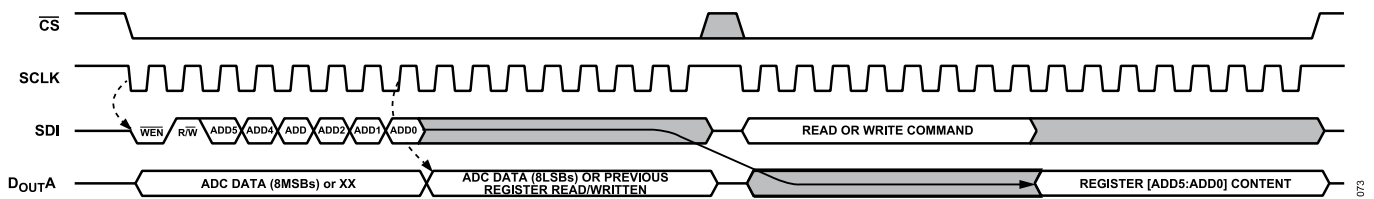

Figure 111. Serial Interface Read Command, First Frame Points the Address, Second Frame Provides the Register Content

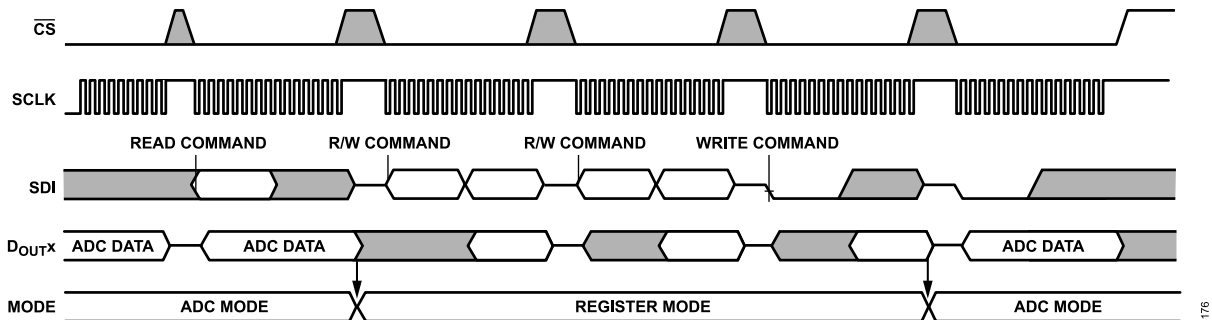

Figure 112. AD7606C-16 Register Mode

Table 27. Status Header, Serial Interface

Bit Details	Bit 7 (MSB)	Bit 6	Bit 5	Bit 4	Bit 3	Bit 2	Bit 1	Bit 0 (LSB)
Content	RESET_DETECT	DIGITAL_ERROR	OPEN_DETECTED	RESERVED	RESERVED	CH.ID 2	CH.ID 1	CH.ID 0
Meaning <sup>1</sup>	Reset detected	Error flag on Address 0x22	The analog input of this channel is open	RESERVED		Channel ID (see Table 24)		

<sup>1</sup> See the Diagnostics section for more information.

DIGITAL INTERFACE

Serial Register Mode (Writing Register Data)

In software mode, all the read/write registers in Table 31 can be written to the serial interface. To write a sequence of registers, exit ADC read mode (default mode) by reading any register on the memory map. A register write command is performed by a single 16-bit SPI access. The format for a write command is shown in Figure 113, and is structured as follows:

- ▶ The first bit clocked in SDI must be set to 0 to enable a write command.
- ▶ The second bit clocked in SDI, the R/W bit, must be cleared to 0.
- ▶ Bit ADD5 to Bit ADD0 clocked in SDI contain the register address to be written.
- ▶ The subsequent eight bits (Bits[DIN7:DIN0]) contain the data to be written to the selected register. Data is clocked in from SDI on

the falling edge of SCLK, while data is clocked out on D<sub>OUT</sub>A on the rising edge of SCLK.

When writing continuously to the device, the data that appears on D<sub>OUT</sub>A is from the register address that was written to on the previous frame, as shown in Figure 113. The D<sub>OUT</sub>B, D<sub>OUT</sub>C, and D<sub>OUT</sub>D lines are kept low during the transmission.

While in register mode, no ADC data is clocked out because the D<sub>OUT</sub>X lines are used to clock out register content. When finished writing all needed registers, a write to Address 0x00 returns the AD7606C-16 to ADC read mode, where the ADC data is again clocked out on the D<sub>OUT</sub>X lines, as shown in Figure 112.

In software mode, when the CRC is turned on, eight additional bits are clocked in and out on each frame. Therefore, 24-bit frames are required.

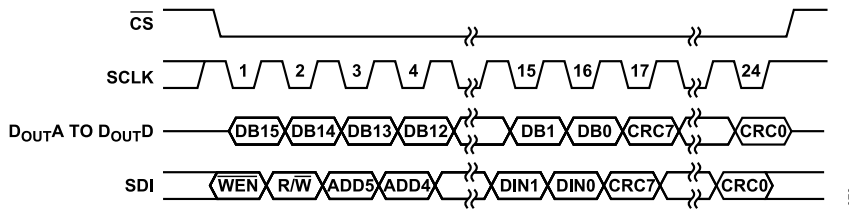

Figure 113. AD7606C-16 Serial Interface, Single Write Command, SDI Clocks in the Address Bit ADD5 to Bit ADD0 and the Register Content Bit DIN7 to Bit DIN0 During the Same Frame, D<sub>OUT</sub>A Provides Register Content Requested on the Previous Frame

DIGITAL INTERFACE

Serial Register Mode with CRC

Registers can be written to and read from the AD7606C-16 with CRC enabled in software mode, by asserting the INT\_CRC\_ERR\_EN bit (Address 0x21, Bit 2).

When reading a register, the AD7606C-16 provides eight additional bits on the D<sub>OUTA</sub> line with the CRC resultant of the data shifted out previously on the same frame. The controller can then check whether the data received is correct by applying the following polynomial:

$$x^8 + x^2 + x + 1 \tag{9}$$

With the CRC enabled, the SPI frames extend to 24 bits in length, as shown in Figure 114.

When writing a register, the controller must clock the data (register address plus register content) in the AD7606C-16 followed by an 8-bit CRC word, calculated from the previous 16 bits using the Equation 9. The AD7606C-16 reads the register address and the register content, calculates the corresponding 8-bit CRC word, and asserts the INT\_CRC\_ERR bit (Address 0x22, Bit 2) if the calculated CRC word does not match the CRC word received between the 17<sup>th</sup> and 24<sup>th</sup> bit through SDI, as shown in Figure 115.

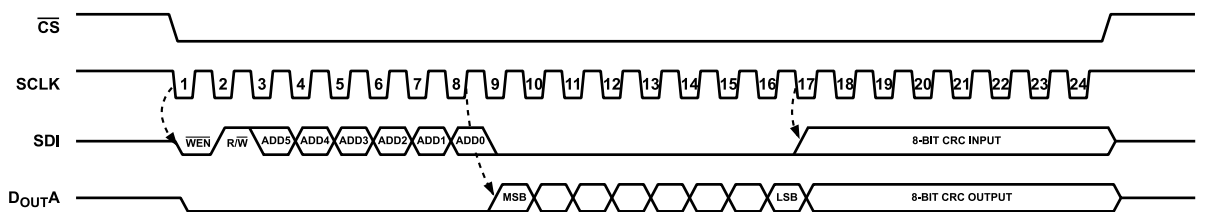

Figure 114. Reading Registers Through the SPI Interface with CRC Enabled

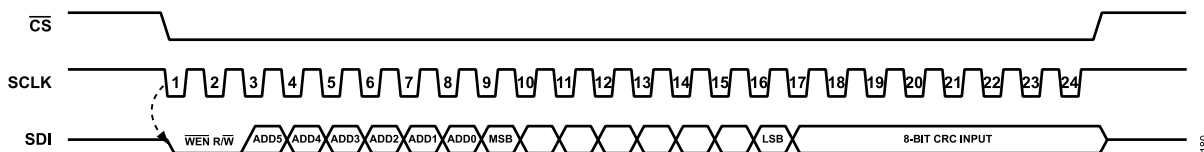

Figure 115. Writing Registers Through the SPI Interface with CRC Enabled

## DIAGNOSTICS

Diagnostic features are available in software mode to verify correct operation of the AD7606C-16. The list of diagnostic monitors includes reset detection, analog input open circuit detection, and digital error detection.

If an error is detected, a flag asserts on the status header, if enabled, as described in the [Digital Interface](#) section. This flag points to the registers on which the error is located, as explained in the following sections.

In addition, a diagnostic multiplexer can dedicate any channel to verify a series of internal nodes, as explained in the [Diagnostics Multiplexer](#) section.

### RESET DETECTION

The RESET\_DETECT bit on the status register (Address 0x01, Bit 7) asserts if either a partial reset or full reset pulse is applied to the AD7606C-16. On power-up, a full reset is required. This reset asserts the RESET\_DETECT bit, indicating that the power-on reset (POR) initialized correctly on the device.

The POR monitors the REGCAP voltage and issues a full reset if the voltage drops under a certain threshold.

The RESET\_DETECT bit can be used to detect an unexpected device reset or a large glitch on the RESET pin, or a voltage drop on the supplies.

The RESET\_DETECT bit is only cleared by reading the status register.

### DIGITAL ERROR

Both the status register and status header contain a DIGITAL\_ERROR bit. This bit asserts when any of the following monitors trigger:

- ▶ Memory map CRC, read only memory (ROM) CRC, and digital interface CRC
- ▶ SPI invalid read or write
- ▶ BUSY stuck high

To find out which monitor triggered the DIGITAL\_ERROR bit, the DIGITAL\_DIAG\_ERR address (Address 0x22) has a bit dedicated for each monitor, as explained in the following sections.

### ROM CRC

The ROM stores the factory trimming settings for the AD7606C-16. After power-up, the ROM content is loaded to registers during device initialization. After the load, a CRC is calculated on the loaded data and verified if the result matches the CRC stored in the ROM.

The AD7606C-16 uses the following 16-bit CRC polynomial to calculate the CRC checksum value on the memory map:

$$x^{16} + x^{14} + x^{12} + x^{10} + x^8 + x^6 + x^4 + x^3 + x + 1 \text{ (0xBAAD)} \quad (10)$$

If the calculated and stored CRC values do not match, the error checking and correction (ECC) block can detect up to 3-bit errors (hamming distance of 4). Otherwise, the ROM\_CRC\_ERR (Address 0x22, Bit 0) asserts. When ROM\_CRC\_ERR asserts after power-up, it is recommended to issue a full reset to reload all factory settings.

This ROM CRC monitoring feature is enabled by default but can be disabled by clearing the ROM\_CRC\_ERR\_EN bit (Address 0x21, Bit 0).

### Memory Map CRC

For added robustness, a CRC calculation is performed on the on-chip registers. The memory map CRC is disabled by default. After the AD7606C-16 is configured in software mode through writing the required registers, the memory map CRC can be enabled through the MM\_CRC\_ERR\_EN bit (Address 0x21, Bit 1). When enabled, the CRC calculation is performed on the entire memory map and stored. Every time the memory map is written, the CRC is recalculated and the new value stored.

The AD7606C-16 uses the following 16-bit CRC polynomial to calculate the CRC checksum value on the memory map:

$$x^{16} + x^{14} + x^{12} + x^{10} + x^8 + x^6 + x^4 + x^3 + x + 1 \text{ (0xBAAD)} \quad (11)$$

The ECC block can detect up to three bits of errors (hamming distance of four bits) within the memory map. Moreover, every 4  $\mu$ s, the CRC on the memory map is recalculated and compared to the stored CRC value. If the calculated and the stored CRC values do not match, the memory map is corrupted and the MM\_CRC\_ERR bit asserts.

If the MM\_CRC\_ERR bit asserts, it is recommended to write to the memory map to recalculate the CRC. If the MM\_CRC\_ERR persists, it is recommended to issue a full reset to restore the default contents of the memory map.

### Interface CRC Checksum

The AD7606C-16 has a CRC checksum mode to improve interface robustness by detecting errors in data transmission. The CRC feature is available in both ADC read modes (serial and parallel) and register mode (serial only).

The AD7606C-16 uses the following 16-bit CRC polynomial to calculate the CRC checksum value:

$$x^{16} + x^{14} + x^{12} + x^{10} + x^8 + x^6 + x^4 + x^3 + x + 1 \text{ (0xBAAD)} \quad (12)$$

To replicate the polynomial division in the hardware, the data shifts left by 16 bits to create a number ending in 16 Logic 0s. The polynomial is aligned so that the MSB is adjacent to the leftmost Logic 1 of the data. An exclusive OR (XOR) function is applied to the data to produce a new, shorter number. The polynomial is again aligned so that the MSB is adjacent to the leftmost Logic 1 of the new result, and the procedure repeats. This process repeats until

DIAGNOSTICS

the original data is reduced to a value less than the polynomial, the 16-bit checksum.

An example of the CRC calculation for the 16-bit data is shown in Table 28. The CRC corresponding to the data 0x064E, using Equation 12, is 0x2137.

The serial interface supports the CRC when enabled via the INT\_CRC\_ERR\_EN bit (Address 0x21, Bit 2). The CRC is a 16-bit word that is appended to the end of each D<sub>OUTX</sub> in use, after reading all the channels. An example using four D<sub>OUTX</sub> lines is shown in Figure 116.

If using two D<sub>OUTX</sub> lines (D<sub>OUTA</sub> and D<sub>OUTB</sub>), each 16-bit CRC word is calculated using data from four channels, that is 64 bits, as shown in Figure 117. If using only one D<sub>OUTX</sub> line, all eight channels are clocked out through D<sub>OUTA</sub>, followed by the 16-bit CRC word calculated using data from the eight channels, that is, 128 bits.

If using four D<sub>OUTX</sub> lines, each 16-bit CRC word is calculated using data from two channels 32 bits. If using eight D<sub>OUTX</sub> lines, each 16-bit CRC word is calculated using data from one channel 16 bits.

Table 28. Example CRC Calculation for 16-Bit Data<sup>1</sup>

Data <sup>2</sup>	0	0	0	0	0	1	1	0	0	1	0	0	1	1	1	0	X	X	X	X	X	X	X	X	X	X	X	X	X	X	X	X									
Process																																									
Data	0	0	0	0	0	1	1	0	0	1	0	0	1	1	1	0	0	0	0	0	0	0	0	0	0	0	0	0	0	0	0	0	0	0							
Polynomial						1	0	1	1	1	0	1	0	1	0	1	0	1	1	0	1	1																			
						0	1	1	1	0	0	1	1	0	1	1	0	1	1	0	1	1	0																		
						1	0	1	1	1	0	1	0	1	0	1	0	1	1	0	1	1																			
						0	1	0	1	1	1	0	0	0	1	1	1	0	1	1	0	1	0																		
							1	0	1	1	1	0	1	0	1	0	1	0	1	1	0	1	1																		
							0	0	0	0	0	0	1	0	0	0	0	0	0	0	0	0	0	1	0	0	0	0	0	0	0	0	0	0	0	0	0	0	0		
CRC																		0	0	1	0	0	0	0	1	0	0	1	0	0	1	1	0	1	1	0	1	1	1	1	

<sup>1</sup> Table 28 represents the division of the data. Blank cells are for formatting purposes.

<sup>2</sup> X means don't care.

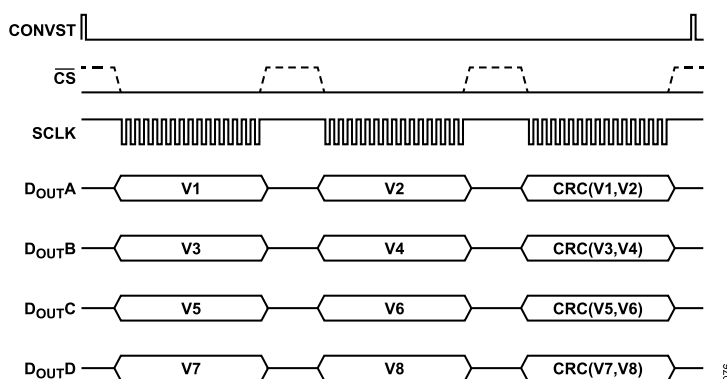

Figure 116. Serial Interface ADC Reading with CRC On, Four D<sub>OUTX</sub> Lines

## DIAGNOSTICS

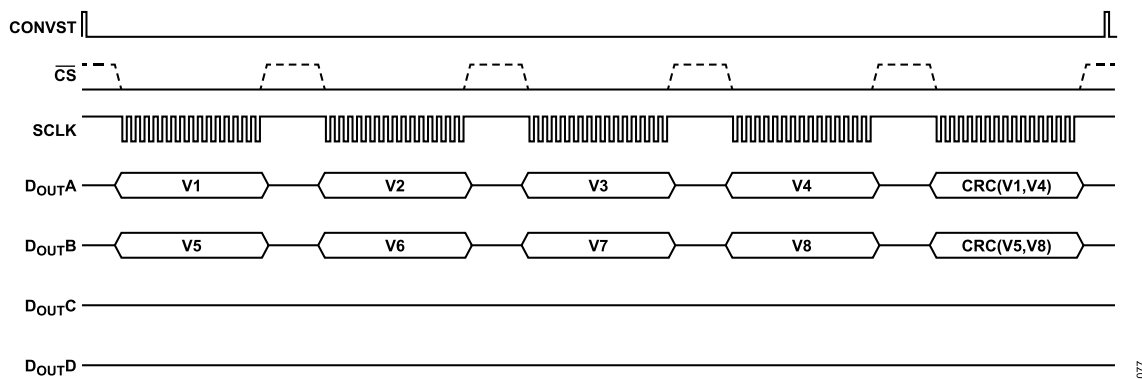

Figure 117. Serial Interface ADC Reading with CRC On, Two  $D_{OUTX}$  Lines

When the AD7606C-16 is in register mode, that is, when registers are being read or written, the CRC polynomial used is  $x^8 + x^2 + x + 1$ . When reading a register, and CRC is enabled, each SPI frame is 24 bits long and the CRC 8-bit word is clocked out from the 17<sup>th</sup> to 24<sup>th</sup> SCLK cycle. Similarly, when writing a register, a CRC word can be appended on the SDI line, as shown in [Figure 113](#) and the AD7606C-16 checks and triggers an error, INT\_CRC\_ERR (Address 0x22, Bit 2), if the CRC given and the internally calculated do not match.

The parallel interface also supports CRC in ADC mode only, and it is clocked out through DB15 to DB0 after Channel 8, as shown in [Figure 102](#). The 16-bit CRC word calculated using data from the eight channels, that is, 128 bits.

### Interface Check

The integrity of the digital interface can be checked by setting the INTERFACE\_CHECK\_EN bit (Address 0x21, Bit 7). Selecting the interface check forces the conversion result registers to a known value, as shown in [Table 29](#).

Verifying that the controller receives the data shown in [Table 29](#) ensures that the interface between the AD7606C-16 and the controller operates properly. If the interface CRC is enabled because the data transmitted is known, this mode verifies that the controller performs the CRC calculation properly.

Table 29. Interface Check Conversion Results

Channel Number	Conversion Result Forced (Hexadecimal)
V1	0xACCA
V2	0x5CC5
V3	0xA33A
V4	0x5335
V5	0xCAAC
V6	0xC55C
V7	0x3AA3
V8	0x3553

### SPI Invalid Read/Write

When attempting to read back an invalid register address, the SPI\_READ\_ERR bit (Address 0x22, Bit 4) is set. The invalid readback address detection can be enabled by setting the SPI\_READ\_ERR\_EN bit (Address 0x21, Bit 4). If an SPI read error is triggered, it is cleared by overwriting that bit or disabling the checker.

When attempting to write to an invalid register address or a read only register, the SPI\_WRITE\_ERR bit (Address 0x22, Bit 3) is set. The invalid write address detection can be enabled by setting the SPI\_WRITE\_ERR\_EN bit (Address 0x21, Bit 3). If an SPI write error is triggered, it is cleared by overwriting that bit or disabling the checker.

### BUSY Stuck High

BUSY stuck high monitoring is enabled by setting the BUSY\_STUCK\_HIGH\_ERR\_EN bit (Address 0x21, Bit 5). After this bit is enabled, the conversion time ( $t_{CONV}$  in [Table 3](#)) is monitored internally with an independent clock. If  $t_{CONV}$  exceeds 4  $\mu$ s, the AD7606C-16 automatically issues a partial reset and asserts the BUSY\_STUCK\_HIGH\_ERR bit (Address 0x22, Bit 5). To clear this error flag, the BUSY\_STUCK\_HIGH\_ERR bit must be overwritten with a 1.

When oversampling mode is enabled, the individual conversion time for each internal conversion is monitored.

DIAGNOSTICS

Internal Clock Counters

The AD7606C-16 uses an internal clock related to functional safety features (FS\_CLK) and an internal clock for oversampling (OS\_CLK). Both internal clocks run at 16 MHz. To verify the clocks are correctly operating, enable the clock counter through the CLK\_FS\_OS\_COUNTER\_EN bit in Register 0x21, Bit 6. These clock counters increment by 1 every time 64 clocks are counted. Therefore, if either the FS\_CLK\_COUNTER register (Address 0x2D) or the OS\_CLK\_COUNTER register (Address 0x2E) is read after a certain known delay that corresponds to the chosen feature, the register values must match the equivalent count for the time elapsed.

For example, if the clock counter is enabled and the FS\_CLK\_COUNTER register is read after 20 μs between the write and read operations, the value must equal to 0x05. The following equation calculates the FS\_CLK\_COUNTER value:

$$FS\_CLK\_COUNTER = Delay \times \frac{16\text{ MHz}}{64} \tag{13}$$

where *Delay* is the delay shown in Figure 120.

DIAGNOSTICS MULTIPLEXER

All eight input channels contain a diagnostics multiplexer in front of the PGA that allows monitoring of the internal nodes described in Table 30 to ensure the correct operation of the AD7606C-16. For accurate measurements, it is recommended to use only Channel 8, where the offset and gain for diagnostic channels have been trimmed in production. Connecting more channels to the diagnostic multiplexer simultaneously degrades the performance.

Table 30 shows the bit decoding for the diagnostic mux register on Channel 1, as an example. When an internal node is selected, the input voltage at input pins are deselected from the PGA, as shown in Figure 118.

Each diagnostic multiplexer configuration is accessed, in software mode through the corresponding register (Address 0x28 to Address 0x2B). To use the multiplexer on one channel, the ±10 V range must be selected on that channel.

Table 30. Diagnostic Mux Register Bit Decoding of Channel 1

Address 0x28			
Bit 2	Bit 1	Bit 0	Signal on Channel 1
0	0	0	V1
0	0	1	Temperature sensor
0	1	0	V <sub>REF</sub>
0	1	1	ALDO
1	0	0	DLDO

Table 30. Diagnostic Mux Register Bit Decoding of Channel 1 (Continued)

Address 0x28			
Bit 2	Bit 1	Bit 0	Signal on Channel 1
1	0	1	V <sub>DRIVE</sub>
1	1	0	AGND
1	1	1	AV <sub>CC</sub>

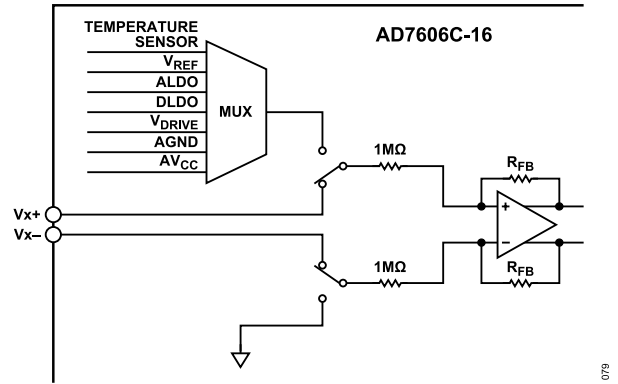

Figure 118. Diagnostic Multiplexer (Channel 1 Shown as an Example) (R<sub>FB</sub> = Feedback Resistor)

Temperature Sensor

The temperature sensor can be selected through the diagnostic multiplexer and converted with the ADC, as shown in Figure 118. The temperature sensor voltage is measured and is proportional to the die temperature, as per the following equation:

$$Temperature(^{\circ}C) = \frac{ADC_{OUT}(V) - 0.18353(V)}{0.000480(V/^{\circ}C)} + 25(^{\circ}C) \tag{14}$$

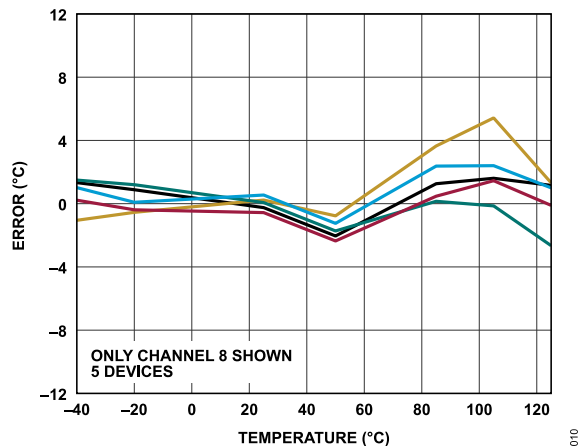

Figure 119. Temperature Sensor Error

DIAGNOSTICS

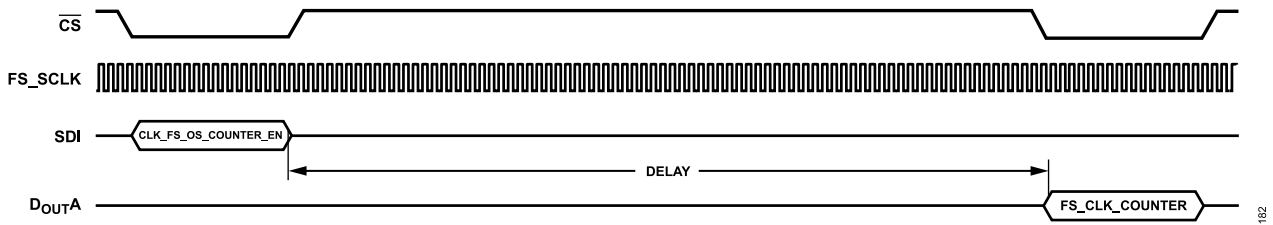

Figure 120. FS\_CLK\_COUNTER Functionality



## DIAGNOSTICS

### Reference Voltage

The reference voltage can be selected through the diagnostic multiplexer and converted with the ADC, as shown in Figure 121. The internal or external reference is selected as the input to the diagnostic multiplexer based on the REF SELECT pin. Ideally, the ADC output follows the voltage reference level ratiometrically. Therefore, if the ADC output goes beyond the expected 2.5 V, either the reference buffer or the PGA is malfunctioning.

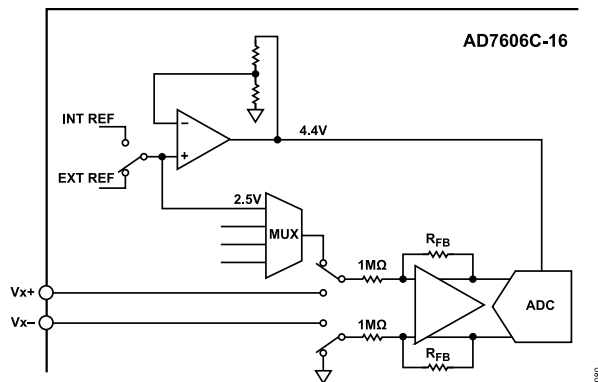

Figure 121. Reference Voltage Signal Path Through the Diagnostic Multiplexer

### Internal LDOs

The analog and digital LDO (REGCAP pins) can be selected through the diagnostic multiplexer and converted with the ADC, as shown in Figure 118. This measurement verifies that each LDO is at the correct operating voltage so that the internal circuitry is biased correctly.

### Supply Voltages

$AV_{CC}$ ,  $V_{DRIVE}$ , and AGND can be selected through the diagnostic multiplexer and converted with the ADC, as shown in Figure 118. This setup ensures the voltage and grounds are applied to the device for correct operation.

If  $V_{DRIVE}$  is below 4.3 V, the following correction factor is needed to measure  $AV_{CC}$  properly:

$$AV_{CC}(V) = ADC_{OUT}(V) - 0.5407 \times V_{DRIVE} + 2.1857(V) \quad (15)$$

**TYPICAL CONNECTION DIAGRAM**

There are four  $AV_{CC}$  supply pins on the device. It is recommended that each of the four pins is decoupled using a 100 nF capacitor at each supply pin and a 10  $\mu$ F capacitor at the supply source. The AD7606C-16 can operate with the internal reference or an externally applied reference. When using a single AD7606C-16 device on the board, decouple the REFIN/REFOUT pin with a 100 nF capacitor. Refer to the Reference section when using an application with multiple AD7606C-16 devices. The REFCAPA and REFCAPB pins are shorted together and decoupled with a 10  $\mu$ F ceramic capacitor.

The  $V_{DRIVE}$  supply is connected to the same supply as the processor. The  $V_{DRIVE}$  voltage controls the voltage value of the output logic signals. For more information on layout, decoupling, and grounding, see the Layout Guidelines section.

After supplies are applied to the AD7606C-16, apply a reset to the AD7606C-16 to ensure that it is configured for the correct mode of operation.

In Figure 122, the AD7606C-16 is configured in hardware mode and is operating with the internal reference because the REF SE-

LECT pin is set to logic high. In this example, the device also uses the parallel interface because the  $\overline{PAR/SER SEL}$  pin is tied to AGND. The analog input range for all eight channels is  $\pm 10$  V, provided the RANGE pin is tied to a high level and the oversampling ratio is controlled through the OSx pins by the controller.

In Figure 123, the AD7606C-16 is configured in software mode, because all three OS2, OS1, and OS0 pins are at logic level high. The oversampling ratio, as well as each channel range, are configured through accessing the memory map. In this example, the  $\overline{PAR/SER SEL}$  pin is at logic level high. Therefore, the serial interface is used for both reading the ADC data and reading and writing the memory map. The REF SELECT pin is tied to AGND. Therefore, the internal reference is disabled and an external reference is connected externally to the REFIN/REFOUT pin and decoupled through a 100 nF capacitor.

Figure 122 and Figure 123 are examples of typical connection diagrams. Other combinations of reference, data interface, and operation mode are also possible, depending on the logic levels applied to each configuration pin.

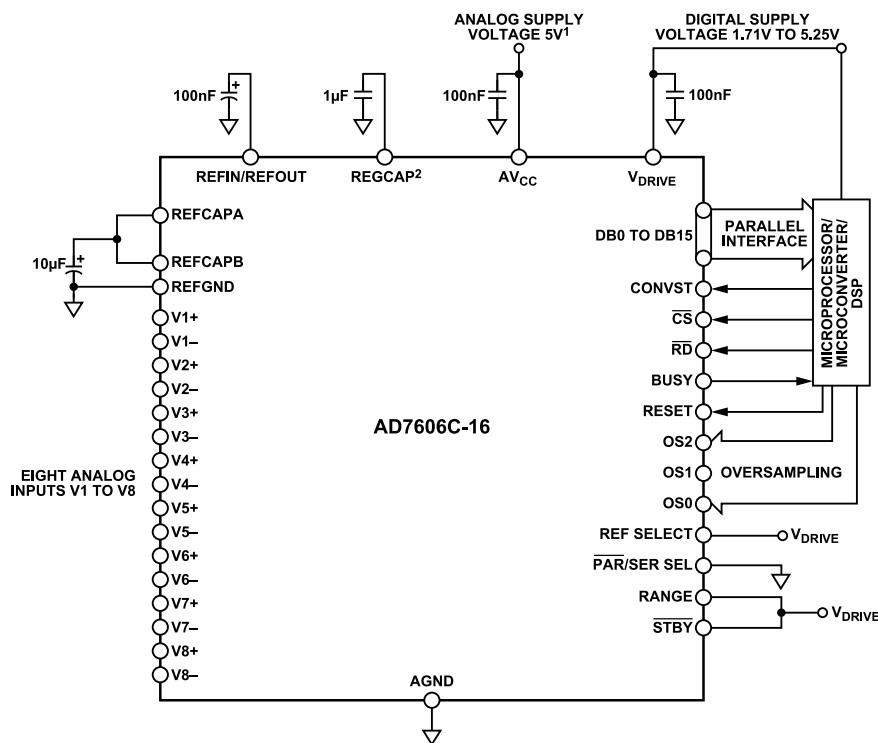

<sup>1</sup>DECOUPLING SHOWN ON THE  $AV_{CC}$  PIN APPLIES TO EACH  $AV_{CC}$  PIN (PIN 1, PIN 37, PIN 38, PIN 48).  
<sup>2</sup>DECOUPLING CAPACITOR CAN BE SHARED BETWEEN  $AV_{CC}$  PIN 37 AND PIN 38.  
<sup>2</sup>DECOUPLING SHOWN ON THE REGCAP PIN APPLIES TO EACH REGCAP PIN (PIN 36, PIN 39).

Figure 122. AD7606C-16 Typical Connection Diagram, Hardware Mode

TYPICAL CONNECTION DIAGRAM

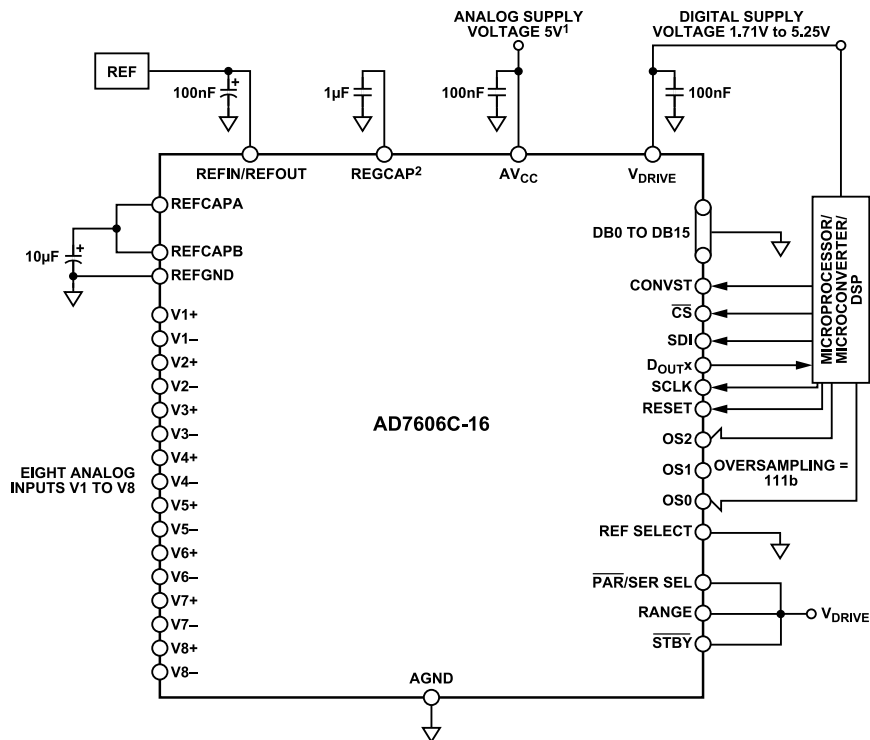

<sup>1</sup>DECOUPLING SHOWN ON THE AV<sub>CC</sub> PIN APPLIES TO EACH AV<sub>CC</sub> PIN (PIN 1, PIN 37, PIN 38, PIN 48).  
 DECOUPLING CAPACITOR CAN BE SHARED BETWEEN AV<sub>CC</sub> PIN 37 AND PIN 38.  
<sup>2</sup>DECOUPLING SHOWN ON THE REGCAP PIN APPLIES TO EACH REGCAP PIN (PIN 36, PIN 39).

082

Figure 123. Typical Connection Diagram, Software Mode

## LAYOUT GUIDELINES

The following layout guidelines are recommended when designing the PCB that houses the AD7606C-16:

- ▶ If the AD7606C-16 is in a system where multiple devices require analog-to-digital ground connections, use a solid ground plane (without splitting between analog and digital grounds).
- ▶ Make stable connections to the ground plane. Avoid sharing one connection for multiple ground pins. Use individual vias or multiple vias to the ground plane for each ground pin. In the case of a split plane, join the digital and analog ground planes in only one place, preferably as close as possible to the AD7606C-16.
- ▶ Avoid running digital lines under the devices because doing so couples noise on the die. Allow the analog ground plane to run under the AD7606C-16 to avoid noise coupling.
- ▶ Shield fast switching signals like CONVST or clocks with digital ground to avoid radiating noise to other sections of the board and ensure that they never run near analog signal paths.
- ▶ Avoid crossover of digital and analog signals.
- ▶ Ensure traces on layers in close proximity on the board run at right angles to each other to reduce the effect of feedthrough through the board.
- ▶ Ensure power supply lines to the  $AV_{CC}$  and  $V_{DRIVE}$  pins on the AD7606C-16. Use as a large trace as possible to provide low impedance paths and reduce the effect of glitches on the power supply lines. Where possible, use supply planes and make stable connections between the AD7606C-16 supply pins and the power tracks on the board. Use a single via or multiple vias for each supply pin.
- ▶ Place the decoupling capacitors close to (ideally, directly against) the supply pins and their corresponding ground pins. Place the decoupling capacitors for the REFIN/REFOUT pin and the REFCAPA pin and REFCAPB pin as close as possible to their respective AD7606C-16 pins. Where possible, place the pins on the same side of the board as the AD7606C-16 device.

Figure 124 shows the recommended decoupling on the top layer of the AD7606C-16 board. Figure 125 shows the bottom layer decoupling, which is used for the four  $AV_{CC}$  pins and the  $V_{DRIVE}$  pin decoupling. Where the ceramic 100 nF caps for the  $AV_{CC}$  pins are placed close to their respective device pins, a single 100 nF capacitor can be shared between Pin 37 and Pin 38.

To ensure stable device-to-device performance matching in a system that contains multiple AD7606C-16 devices, a symmetrical layout between the AD7606C-16 devices is important.

Figure 126 shows a layout with two AD7606C-16 devices. The  $AV_{CC}$  supply plane runs to the right of both devices, and the  $V_{DRIVE}$  supply track runs to the left of the two devices. The reference chip is positioned between the two devices, and the reference voltage track runs north to Pin 42 of U1 and south to Pin 42 of U2. A solid ground plane is used.

These symmetrical layout principles can also be applied to a system that contains more than two AD7606C-16 devices. The

AD7606C-16 devices can be placed in a north to south direction, with the reference voltage located midway between the devices and the reference track running in the north-south direction, similar to Figure 126.

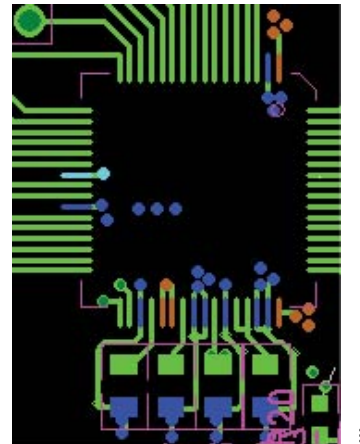

Figure 124. Top Layer Decoupling REFIN/REFOUT, REFCAPA, REFCAPB, and REGCAP Pins

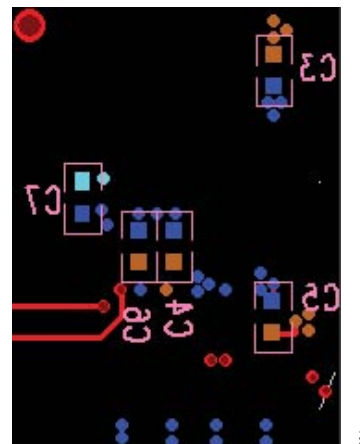

Figure 125. Bottom Layer Decoupling

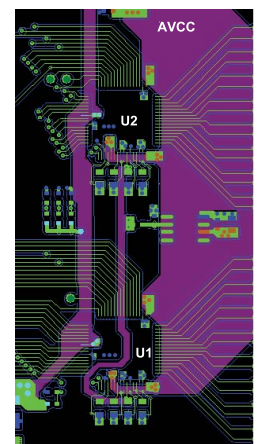

Figure 126. Layout for Multiple AD7606C-16 Devices—Top Layer and Supply Plane Layer

## REGISTER SUMMARY

Table 31. Register Summary

Addr	Name	Bit 7	Bit 6	Bit 5	Bit 4	Bit 3	Bit 2	Bit 1	Bit 0	Reset	RW	
0x01	STATUS	RESET_DETECT	DIGITAL_ERROR	OPEN_DETECTED	RESERVED					0x00	R	
0x02	CONFIG	RESERVED	STATUS_HEADER	EXT_OS_CLOCK	DOUT_FORMAT		RESERVED	OPERATION_MODE		0x08	R/W	
0x03	RANGE_CH1_CH2	CH2_RANGE				CH1_RANGE					0x33	R/W
0x04	RANGE_CH3_CH4	CH4_RANGE				CH3_RANGE					0x33	R/W
0x05	RANGE_CH5_CH6	CH6_RANGE				CH5_RANGE					0x33	R/W
0x06	RANGE_CH7_CH8	CH8_RANGE				CH7_RANGE					0x33	R/W
0x07	BANDWIDTH	CH8_BW	CH7_BW	CH6_BW	CH5_BW	CH4_BW	CH3_BW	CH2_BW	CH1_BW	0x00	R/W	
0x08	OVERSAMPLING	OS_PAD				OS_RATIO					0x00	R/W
0x09	CH1_GAIN	RESERVED			CH1_GAIN					0x00	R/W	
0x0A	CH2_GAIN	RESERVED			CH2_GAIN					0x00	R/W	
0x0B	CH3_GAIN	RESERVED			CH3_GAIN					0x00	R/W	
0x0C	CH4_GAIN	RESERVED			CH4_GAIN					0x00	R/W	
0x0D	CH5_GAIN	RESERVED			CH5_GAIN					0x00	R/W	
0x0E	CH6_GAIN	RESERVED			CH6_GAIN					0x00	R/W	
0x0F	CH7_GAIN	RESERVED			CH7_GAIN					0x00	R/W	
0x10	CH8_GAIN	RESERVED			CH8_GAIN					0x00	R/W	
0x11	CH1_OFFSET	CH1_OFFSET									0x80	R/W
0x12	CH2_OFFSET	CH2_OFFSET									0x80	R/W
0x13	CH3_OFFSET	CH3_OFFSET									0x80	R/W
0x14	CH4_OFFSET	CH4_OFFSET									0x80	R/W
0x15	CH5_OFFSET	CH5_OFFSET									0x80	R/W
0x16	CH6_OFFSET	CH6_OFFSET									0x80	R/W
0x17	CH7_OFFSET	CH7_OFFSET									0x80	R/W
0x18	CH8_OFFSET	CH8_OFFSET									0x80	R/W
0x19	CH1_PHASE	CH1_PHASE_OFFSET									0x00	R/W
0x1A	CH2_PHASE	CH2_PHASE_OFFSET									0x00	R/W
0x1B	CH3_PHASE	CH3_PHASE_OFFSET									0x00	R/W
0x1C	CH4_PHASE	CH4_PHASE_OFFSET									0x00	R/W
0x1D	CH5_PHASE	CH5_PHASE_OFFSET									0x00	R/W
0x1E	CH6_PHASE	CH6_PHASE_OFFSET									0x00	R/W
0x1F	CH7_PHASE	CH7_PHASE_OFFSET									0x00	R/W
0x20	CH8_PHASE	CH8_PHASE_OFFSET									0x00	R/W
0x21	DIGITAL_DIAG_ENABLE	INTERFACE_CHECK_EN	CLK_FS_OS_COUNTER_EN	BUSY_STUCK_HIGH_ERR_EN	SPI_READ_ERR_EN	SPI_WRITE_ERR_EN	INT_CRC_ERR_EN	MM_CRC_ERR_EN	ROM_CRC_ERR_EN	0x01	R/W	
0x22	DIGITAL_DIAG_ERR	RESERVED			BUSY_STUCK_HIGH_ERR	SPI_READ_ERR	SPI_WRITE_ERR	INT_CRC_ERR	MM_CRC_ERR	ROM_CRC_ERR	0x00	R/W
0x23	OPEN_DETECT_ENABLE	CH8_OPEN_DETECT_EN	CH7_OPEN_DETECT_EN	CH6_OPEN_DETECT_EN	CH5_OPEN_DETECT_EN	CH4_OPEN_DETECT_EN	CH3_OPEN_DETECT_EN	CH2_OPEN_DETECT_EN	CH1_OPEN_DETECT_EN	0x00	R/W	

## REGISTER SUMMARY

Table 31. Register Summary (Continued)

Addr	Name	Bit 7	Bit 6	Bit 5	Bit 4	Bit 3	Bit 2	Bit 1	Bit 0	Reset	RW
0x24	OPEN_DETECTED	CH8_OPEN	CH7_OPEN	CH6_OPEN	CH5_OPEN	CH4_OPEN	CH3_OPEN	CH2_OPEN	CH1_OPEN	0x00	R/W
0x28	DIAGNOSTIC_MUX_CH1_2	RESERVED		CH2_DIAG_MUX_CTRL			CH1_DIAG_MUX_CTRL			0x00	R/W
0x29	DIAGNOSTIC_MUX_CH3_4	RESERVED		CH4_DIAG_MUX_CTRL			CH3_DIAG_MUX_CTRL			0x00	R/W
0x2A	DIAGNOSTIC_MUX_CH5_6	RESERVED		CH6_DIAG_MUX_CTRL			CH5_DIAG_MUX_CTRL			0x00	R/W
0x2B	DIAGNOSTIC_MUX_CH7_8	RESERVED		CH8_DIAG_MUX_CTRL			CH7_DIAG_MUX_CTRL			0x00	R/W
0x2C	OPEN_DETECT_QUEUE	OPEN_DETECT_QUEUE								0x00	R/W
0x2D	FS_CLK_COUNTER	CLK_FS_COUNTER								0x00	R
0x2E	OS_CLK_COUNTER	CLK_OS_COUNTER								0x00	R
0x2F	ID	DEVICE_ID				SILICON_REVISION				0x23	R

## REGISTER DETAILS

Address: 0x01, Reset: 0x00, Name: STATUS

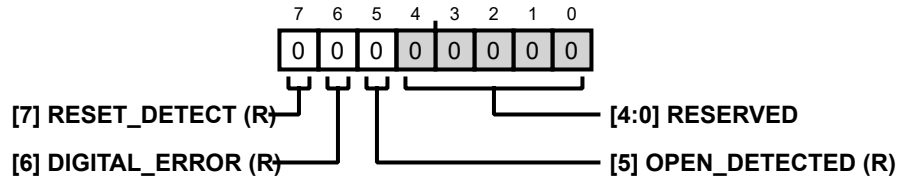

Table 32. Bit Descriptions for STATUS

Bits	Bit Name	Description	Reset	Access
7	RESET_DETECT	A reset has been detected, either full or partial reset.	0x0	R
6	DIGITAL_ERROR	Error present in DIGITAL_DIAG_ERROR register.	0x0	R
5	OPEN_DETECTED	Open Circuit Detected. Check the OPEN_DETECTED register (Address 0x24) to determine which channel is affected.	0x0	R
[4:0]	RESERVED	Reserved.	0x0	R

Address: 0x02, Reset: 0x08, Name: CONFIG

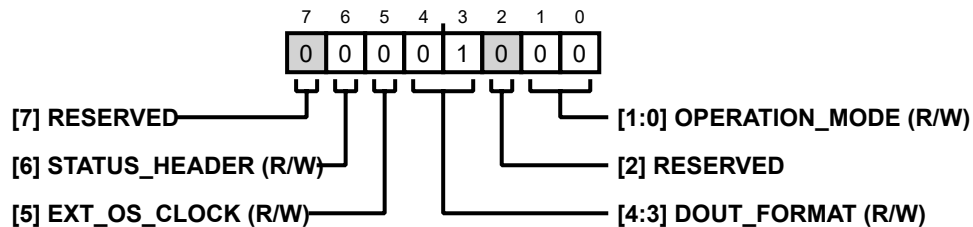
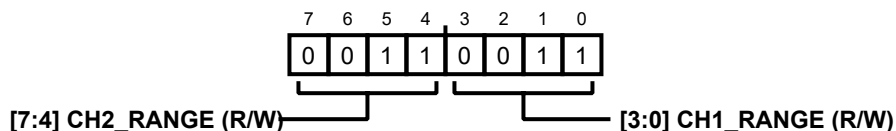

Table 33. Bit Descriptions for CONFIG

Bits	Bit Name	Description	Reset	Access
7	RESERVED	Reserved.	0x0	R
6	STATUS_HEADER	Enable STATUS header to be appended to ADC data in both serial and parallel interface.	0x0	R/W
5	EXT_OS_CLOCK	In oversampling mode, enable external oversampling clock. Oversampling conversions are triggered through a clock signal applied to CONVST pin, instead of managed by the internal oversampling clock.	0x0	R/W
[4:3]	DOUT_FORMAT	Number of D <sub>OUTX</sub> lines used in serial mode when reading conversions. 00: 1 D <sub>OUTX</sub> . 01: 2 D <sub>OUTX</sub> . 10: 4 D <sub>OUTX</sub> . 11: 8 D <sub>OUTX</sub> .	0x1	R/W
2	RESERVED	Reserved.	0x0	R
[1:0]	OPERATION_MODE	Operation mode. 00: normal mode. 01: standby mode. 10: autostandby mode. 11: shutdown mode.	0x0	R/W

Address: 0x03, Reset: 0x33, Name: RANGE\_CH1\_CH2



REGISTER DETAILS

Table 34. Bit Descriptions for RANGE\_CH1\_CH2

Bits	Bit Name	Description	Reset	Access
[7:4]	CH2_RANGE	Range options for Channel 2. 0000: ±2.5 V single-ended range. 0001: ±5 V single-ended range. 0010: ±6.25 V single-ended range. 0011: ±10 V single-ended range. 0100: ±12.5 V single-ended range. 0101: 0 V to 5 V single-ended range. 0110: 0 V to 10 V single-ended range. 0111: 0 V to 12.5 V single-ended range. 1000: ±5 V differential range. 1001: ±10 V differential range. 1010: ±12.5 V differential range. 1011: ±20 V differential range. 1100: reserved. 1101: reserved. 1110: reserved. 1111: reserved.	0x3	R/W
[3:0]	CH1_RANGE	Range options for Channel 1. 0000: ±2.5 V single-ended range. 0001: ±5 V single-ended range. 0010: ±6.25 V single-ended range. 0011: ±10 V single-ended range. 0100: ±12.5 V single-ended range. 0101: 0 V to 5 V single-ended range. 0110: 0 V to 10 V single-ended range. 0111: 0 V to 12.5 V single-ended range. 1000: ±5 V differential range. 1001: ±10 V differential range. 1010: ±12.5 V differential range. 1011: ±20 V differential range. 1100: reserved. 1101: reserved. 1110: reserved. 1111: reserved.	0x3	R/W

Address: 0x04, Reset: 0x33, Name: RANGE\_CH3\_CH4

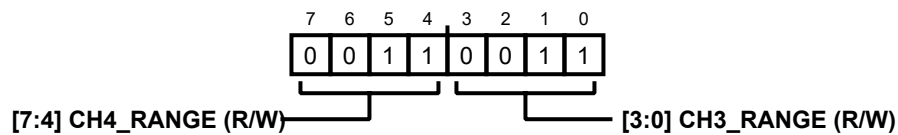

Table 35. Bit Descriptions for RANGE\_CH3\_CH4

Bits	Bit Name	Description	Reset	Access
[7:4]	CH4_RANGE	Range options for Channel 4. 0000: ±2.5 V single-ended range. 0001: ±5 V single-ended range. 0010: ±6.25 V single-ended range.	0x3	R/W



## REGISTER DETAILS

Table 35. Bit Descriptions for RANGE\_CH3\_CH4 (Continued)

Bits	Bit Name	Description	Reset	Access
		0011: $\pm 10$ V single-ended range. 0100: $\pm 12.5$ V single-ended range. 0101: 0 V to 5 V single-ended range. 0110: 0 V to 10 V single-ended range. 0111: 0 V to 12.5 V single-ended range. 1000: $\pm 5$ V differential range. 1001: $\pm 10$ V differential range. 1010: $\pm 12.5$ V differential range. 1011: $\pm 20$ V differential range. 1100: reserved. 1101: reserved. 1110: reserved. 1111: reserved.		
[3:0]	CH3_RANGE	Range options for Channel 3. 0000: $\pm 2.5$ V single-ended range. 0001: $\pm 5$ V single-ended range. 0010: $\pm 6.25$ V single-ended range. 0011: $\pm 10$ V single-ended range. 0100: $\pm 12.5$ V single-ended range. 0101: 0 V to 5 V single-ended range. 0110: 0 V to 10 V single-ended range. 0111: 0 V to 12.5 V single-ended range. 1000: $\pm 5$ V differential range. 1001: $\pm 10$ V differential range. 1010: $\pm 12.5$ V differential range. 1011: $\pm 20$ V differential range. 1100: reserved. 1101: reserved. 1110: reserved. 1111: reserved.	0x3	R/W

Address: 0x05, Reset: 0x33, Name: RANGE\_CH5\_CH6

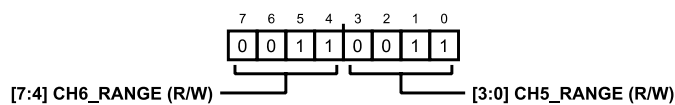

Table 36. Bit Descriptions for RANGE\_CH5\_CH6

Bits	Bit Name	Description	Reset	Access
[7:4]	CH6_RANGE	Range options for Channel 6. 0000: $\pm 2.5$ V single-ended range. 0001: $\pm 5$ V single-ended range. 0010: $\pm 6.25$ V single-ended range. 0011: $\pm 10$ V single-ended range. 0100: $\pm 12.5$ V single-ended range. 0101: 0 V to 5 V single-ended range. 0110: 0 V to 10 V single-ended range. 0111: 0 V to 12.5 V single-ended range. 1000: $\pm 5$ V differential range. 1001: $\pm 10$ V differential range.	0x3	R/W

REGISTER DETAILS

Table 36. Bit Descriptions for RANGE\_CH5\_CH6 (Continued)

Bits	Bit Name	Description	Reset	Access
		1010: ±12.5 V differential range. 1011: ±20 V differential range. 1100: reserved. 1101: reserved. 1110: reserved. 1111: reserved.		
[3:0]	CH5_RANGE	Range options for Channel 5. 0000: ±2.5 V single-ended range. 0001: ±5 V single-ended range. 0010: ±6.25 V single-ended range. 0011: ±10 V single-ended range. 0100: ±12.5 V single-ended range. 0101: 0 V to 5 V single-ended range. 0110: 0 V to 10 V single-ended range. 0111: 0 V to 12.5 V single-ended range. 1000: ±5 V differential range. 1001: ±10 V differential range. 1010: ±12.5 V differential range. 1011: ±20 V differential range. 1100: reserved. 1101: reserved. 1110: reserved. 1111: reserved.	0x3	R/W

Address: 0x06, Reset: 0x33, Name: RANGE\_CH7\_CH8

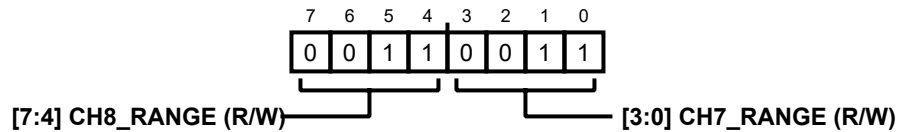

Table 37. Bit Descriptions for RANGE\_CH7\_CH8

Bits	Bit Name	Description	Reset	Access
[7:4]	CH8_RANGE	Range options for Channel 8. 0000: ±2.5 V single-ended range. 0001: ±5 V single-ended range. 0010: ±6.25 V single-ended range. 0011: ±10 V single-ended range. 0100: ±12.5 V single-ended range. 0101: 0 V to 5 V single-ended range. 0110: 0 V to 10 V single-ended range. 0111: 0 V to 12.5 V single-ended range. 1000: ±5 V differential range. 1001: ±10 V differential range. 1010: ±12.5 V differential range. 1011: ±20 V differential range. 1100: reserved. 1101: reserved. 1110: reserved.	0x3	R/W

REGISTER DETAILS

Table 37. Bit Descriptions for RANGE\_CH7\_CH8 (Continued)

Bits	Bit Name	Description	Reset	Access
[3:0]	CH7_RANGE	1111: reserved. Range options for Channel 7. 0000: ±2.5 V single-ended range. 0001: ±5 V single-ended range. 0010: ±6.25 V single-ended range. 0011: ±10 V single-ended range. 0100: ±12.5 V single-ended range. 0101: 0 V to 5 V single-ended range. 0110: 0 V to 10 V single-ended range. 0111: 0 V to 12.5 V single-ended range. 1000: ±5 V differential range. 1001: ±10 V differential range. 1010: ±12.5 V differential range. 1011: ±20 V differential range. 1100: reserved. 1101: reserved. 1110: reserved. 1111: reserved.	0x3	R/W

Address: 0x07, Reset: 0x00, Name: BANDWIDTH

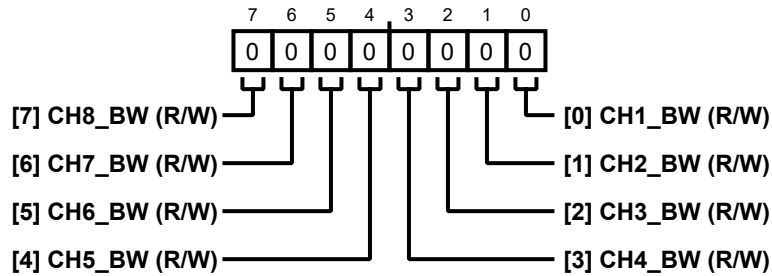
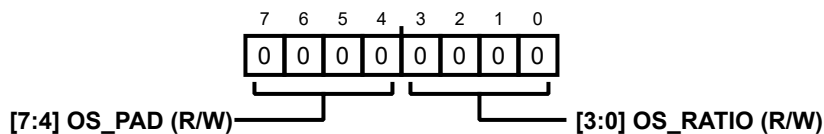

Table 38. Bit Descriptions for BANDWIDTH

Bits	Bit Name	Description	Reset	Access
7	CH8_BW	Enables high bandwidth mode on Channel 8.	0x0	R/W
6	CH7_BW	Enables high bandwidth mode on Channel 7.	0x0	R/W
5	CH6_BW	Enables high bandwidth mode on Channel 6.	0x0	R/W
4	CH5_BW	Enables high bandwidth mode on Channel 5.	0x0	R/W
3	CH4_BW	Enables high bandwidth mode on Channel 4.	0x0	R/W
2	CH3_BW	Enables high bandwidth mode on Channel 3.	0x0	R/W
1	CH2_BW	Enables high bandwidth mode on Channel 2.	0x0	R/W
0	CH1_BW	Enables high bandwidth mode on Channel 1.	0x0	R/W

Address: 0x08, Reset: 0x00, Name: OVERSAMPLING



## REGISTER DETAILS

Table 39. Bit Descriptions for OVERSAMPLING

Bits	Bit Name	Description	Reset	Access
[7:4]	OS_PAD	Oversampling padding, extend the internal oversampling period allowing evenly spaced sampling between CONVST rising edges.	0x0	R/W
[3:0]	OS_RATIO	Oversampling ratio. 0: no oversampling. 1: oversampling by 2. 10: oversampling by 4. 11: oversampling by 8. 100: oversampling by 16. 101: oversampling by 32. 110: oversampling by 64. 111: oversampling by 128. 1000: oversampling by 256. 1001: oversampling off. 1010: oversampling off. 1011: oversampling off. 1100: oversampling off. 1101: oversampling off. 1110: oversampling off. 1111: oversampling off.	0x0	R/W

Address: 0x09, Reset: 0x00, Name: CH1\_GAIN

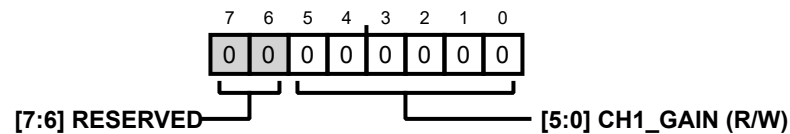

Table 40. Bit Descriptions for CH1\_GAIN

Bits	Bit Name	Description	Reset	Access
[7:6]	RESERVED	Reserved.	0x0	R
[5:0]	CH1_GAIN	R <sub>FILTER</sub> calibration register. Resolution: 1024 Ω. Range: 0 Ω to 65,536 Ω.	0x0	R/W

Address: 0x0A, Reset: 0x00, Name: CH2\_GAIN

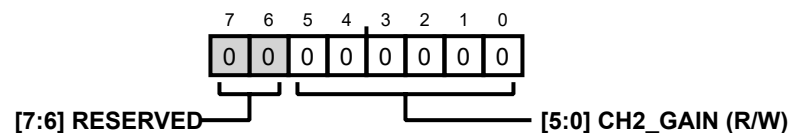

Table 41. Bit Descriptions for CH2\_GAIN

Bits	Bit Name	Description	Reset	Access
[7:6]	RESERVED	Reserved.	0x0	R
[5:0]	CH2_GAIN	R <sub>FILTER</sub> calibration register. Resolution: 1024 Ω. Range: 0 Ω to 65,536 Ω.	0x0	R/W

Address: 0x0B, Reset: 0x00, Name: CH3\_GAIN

## REGISTER DETAILS

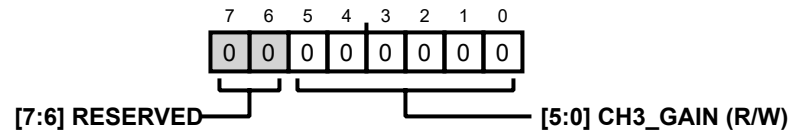

Table 42. Bit Descriptions for CH3\_GAIN

Bits	Bit Name	Description	Reset	Access
[7:6]	RESERVED	Reserved.	0x0	R
[5:0]	CH3_GAIN	R <sub>FILTER</sub> calibration register. Resolution: 1024 Ω. Range: 0 Ω to 65,536 Ω.	0x0	R/W

Address: 0x0C, Reset: 0x00, Name: CH4\_GAIN

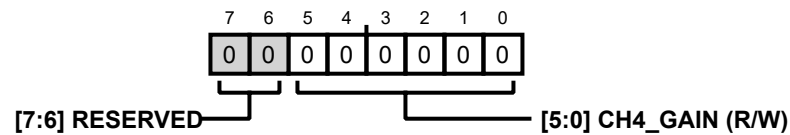

Table 43. Bit Descriptions for CH4\_GAIN

Bits	Bit Name	Description	Reset	Access
[7:6]	RESERVED	Reserved.	0x0	R
[5:0]	CH4_GAIN	R <sub>FILTER</sub> calibration register. Resolution: 1024 Ω. Range: 0 Ω to 65,536 Ω.	0x0	R/W

Address: 0x0D, Reset: 0x00, Name: CH5\_GAIN

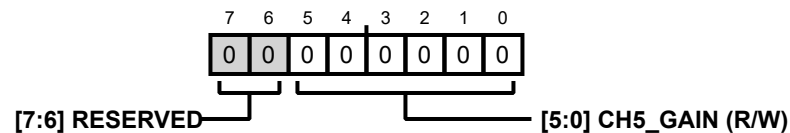

Table 44. Bit Descriptions for CH5\_GAIN

Bits	Bit Name	Description	Reset	Access
[7:6]	RESERVED	Reserved.	0x0	R
[5:0]	CH5_GAIN	R <sub>FILTER</sub> calibration register. Resolution: 1024 Ω. Range: 0 Ω to 65,536 Ω.	0x0	R/W

Address: 0x0E, Reset: 0x00, Name: CH6\_GAIN

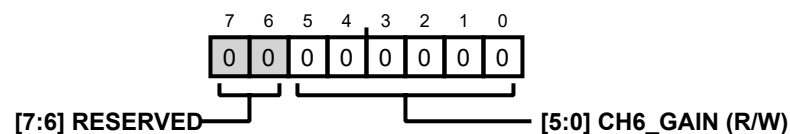

Table 45. Bit Descriptions for CH6\_GAIN

Bits	Bit Name	Description	Reset	Access
[7:6]	RESERVED	Reserved.	0x0	R
[5:0]	CH6_GAIN	R <sub>FILTER</sub> calibration register. Resolution: 1024 Ω. Range: 0 Ω to 65,536 Ω.	0x0	R/W

Address: 0x0F, Reset: 0x00, Name: CH7\_GAIN

## REGISTER DETAILS

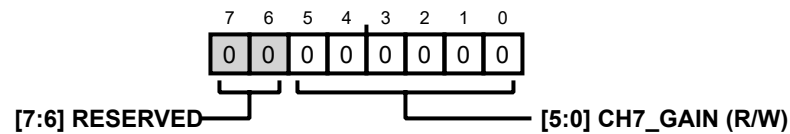

Table 46. Bit Descriptions for CH7\_GAIN

Bits	Bit Name	Description	Reset	Access
[7:6]	RESERVED	Reserved.	0x0	R
[5:0]	CH7_GAIN	R <sub>FILTER</sub> calibration register. Resolution: 1024 Ω. Range: 0 Ω to 65,536 Ω.	0x0	R/W

Address: 0x10, Reset: 0x00, Name: CH8\_GAIN

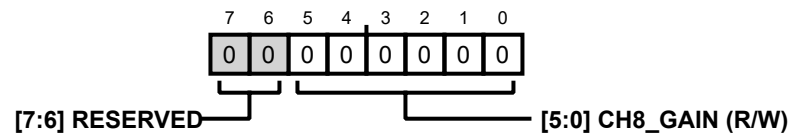

Table 47. Bit Descriptions for CH8\_GAIN

Bits	Bit Name	Description	Reset	Access
[7:6]	RESERVED	Reserved.	0x0	R
[5:0]	CH8_GAIN	R <sub>FILTER</sub> calibration register. Resolution: 1024 Ω. Range: 0 Ω to 65,536 Ω.	0x0	R/W

Address: 0x11, Reset: 0x80, Name: CH1\_OFFSET

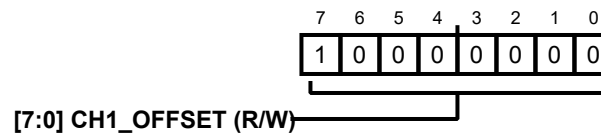

Table 48. Bit Descriptions for CH1\_OFFSET

Bits	Bit Name	Description	Reset	Access
[7:0]	CH1_OFFSET	Offset register to remove external system offset errors. Range from -128 LSB to +127 LSB.	0x80	R/W

Address: 0x12, Reset: 0x80, Name: CH2\_OFFSET

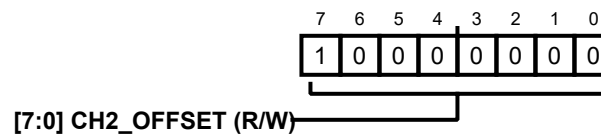

Table 49. Bit Descriptions for CH2\_OFFSET

Bits	Bit Name	Description	Reset	Access
[7:0]	CH2_OFFSET	Offset register to remove external system offset errors. Range from -128 LSB to +127 LSB	0x80	R/W

Address: 0x13, Reset: 0x80, Name: CH3\_OFFSET

REGISTER DETAILS

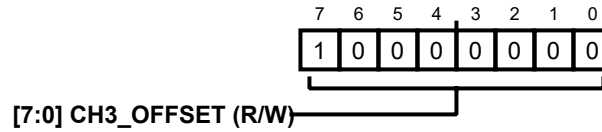

Table 50. Bit Descriptions for CH3\_OFFSET

Bits	Bit Name	Description	Reset	Access
[7:0]	CH3_OFFSET	Offset register to remove external system offset errors. Range from -128 LSB to +127 LSB	0x80	R/W

Address: 0x14, Reset: 0x80, Name: CH4\_OFFSET

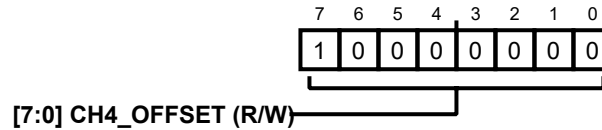

Table 51. Bit Descriptions for CH4\_OFFSET

Bits	Bit Name	Description	Reset	Access
[7:0]	CH4_OFFSET	Offset register to remove external system offset errors. Range from -128 LSB to +127 LSB	0x80	R/W

Address: 0x15, Reset: 0x80, Name: CH5\_OFFSET

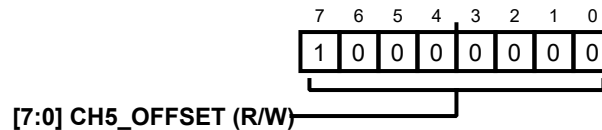

Table 52. Bit Descriptions for CH5\_OFFSET

Bits	Bit Name	Description	Reset	Access
[7:0]	CH5_OFFSET	Offset register to remove external system offset errors. Range from -128 LSB to +127 LSB	0x80	R/W

Address: 0x16, Reset: 0x80, Name: CH6\_OFFSET

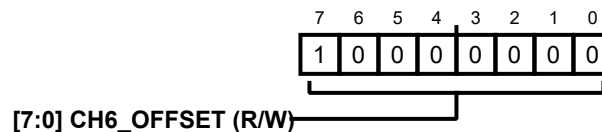
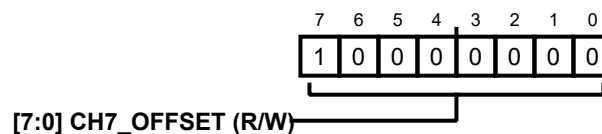

Table 53. Bit Descriptions for CH6\_OFFSET

Bits	Bit Name	Description	Reset	Access
[7:0]	CH6_OFFSET	Offset register to remove external system offset errors. Range from -128 LSB to +127 LSB	0x80	R/W

Address: 0x17, Reset: 0x80, Name: CH7\_OFFSET



## REGISTER DETAILS

Table 54. Bit Descriptions for CH7\_OFFSET

Bits	Bit Name	Description	Reset	Access
[7:0]	CH7_OFFSET	Offset register to remove external system offset errors. Range from -128 LSB to +127 LSB	0x80	R/W

Address: 0x18, Reset: 0x80, Name: CH8\_OFFSET

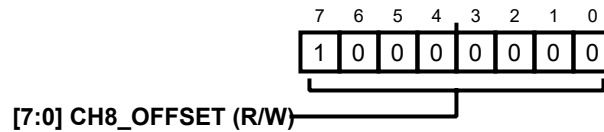

Table 55. Bit Descriptions for CH8\_OFFSET

Bits	Bit Name	Description	Reset	Access
[7:0]	CH8_OFFSET	Offset register to remove external system offset errors. Range from -128 LSB to +127 LSB	0x80	R/W

Address: 0x19, Reset: 0x00, Name: CH1\_PHASE

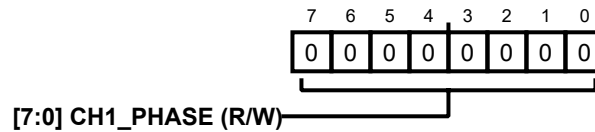

Table 56. Bit Descriptions for CH1\_PHASE

Bits	Bit Name	Description	Reset	Access
[7:0]	CH1_PHASE_OFFSET	Phase delay from 0 $\mu$ s to 255 $\mu$ s in steps of 1 $\mu$ s.	0x0	R/W

Address: 0x1A, Reset: 0x00, Name: CH2\_PHASE

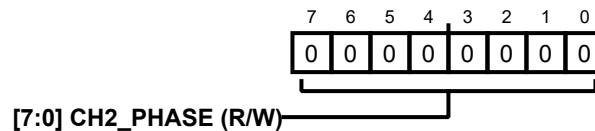

Table 57. Bit Descriptions for CH2\_PHASE

Bits	Bit Name	Description	Reset	Access
[7:0]	CH2_PHASE_OFFSET	Phase delay from 0 $\mu$ s to 255 $\mu$ s in steps of 1 $\mu$ s.	0x0	R/W

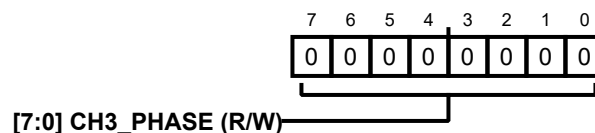

Table 58. Bit Descriptions for CH3\_PHASE

Bits	Bit Name	Description	Reset	Access
[7:0]	CH3_PHASE_OFFSET	Phase delay from 0 $\mu$ s to 255 $\mu$ s in steps of 1 $\mu$ s.	0x0	R/W

Address: 0x1C, Reset: 0x00, Name: CH4\_PHASE



REGISTER DETAILS

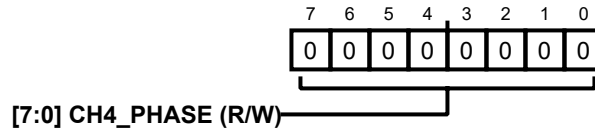

Table 59. Bit Descriptions for CH4\_PHASE

Bits	Bit Name	Description	Reset	Access
[7:0]	CH4_PHASE_OFFSET	Phase delay from 0 $\mu$ s to 255 $\mu$ s in steps of 1 $\mu$ s.	0x0	R/W

Address: 0x1D, Reset: 0x00, Name: CH5\_PHASE

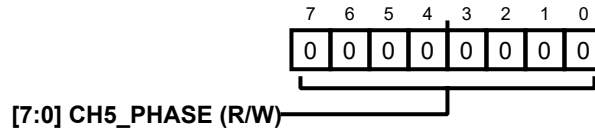

Table 60. Bit Descriptions for CH5\_PHASE

Bits	Bit Name	Description	Reset	Access
[7:0]	CH5_PHASE_OFFSET	Phase delay from 0 $\mu$ s to 255 $\mu$ s in steps of 1 $\mu$ s.	0x0	R/W

Address: 0x1E, Reset: 0x00, Name: CH6\_PHASE

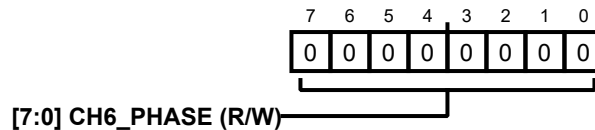

Table 61. Bit Descriptions for CH6\_PHASE

Bits	Bit Name	Description	Reset	Access
[7:0]	CH6_PHASE_OFFSET	Phase delay from 0 $\mu$ s to 255 $\mu$ s in steps of 1 $\mu$ s.	0x0	R/W

Address: 0x1F, Reset: 0x00, Name: CH7\_PHASE

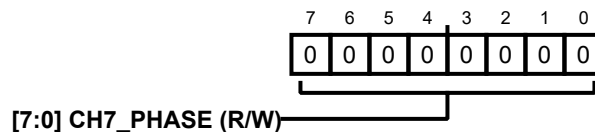
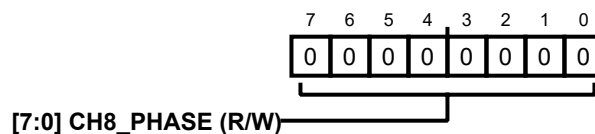

Table 62. Bit Descriptions for CH7\_PHASE

Bits	Bit Name	Description	Reset	Access
[7:0]	CH7_PHASE_OFFSET	Phase delay from 0 $\mu$ s to 255 $\mu$ s in steps of 1 $\mu$ s.	0x0	R/W

Address: 0x20, Reset: 0x00, Name: CH8\_PHASE



## REGISTER DETAILS

Table 63. Bit Descriptions for CH8\_PHASE

Bits	Bit Name	Description	Reset	Access
[7:0]	CH8_PHASE_OFFSET	Phase delay from 0 $\mu$ s to 255 $\mu$ s in steps of 1 $\mu$ s.	0x0	R/W

Address: 0x21, Reset: 0x01, Name: DIGITAL\_DIAG\_ENABLE

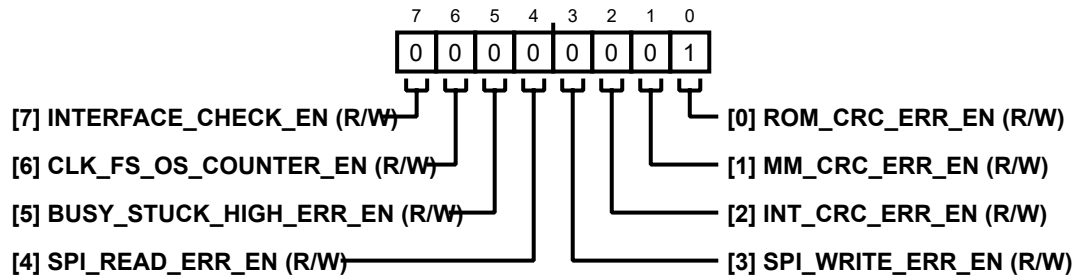

Table 64. Bit Descriptions for DIGITAL\_DIAG\_ENABLE

Bits	Bit Name	Description	Reset	Access
7	INTERFACE_CHECK_EN	Enable interface check. Provides a fixed data on each channel when reading ADC data.	0x0	R/W
6	CLK_FS_OS_COUNTER_EN	Enable FS and OS clock counter.	0x0	R/W
5	BUSY_STUCK_HIGH_ERR_EN	Enable busy stuck high check.	0x0	R/W
4	SPI_READ_ERR_EN	Enable checking if attempting to read from an invalid address.	0x0	R/W
3	SPI_WRITE_ERR_EN	Enable checking if attempting to write to an invalid address.	0x0	R/W
2	INT_CRC_ERR_EN	Enable interface CRC check.	0x0	R/W
1	MM_CRC_ERR_EN	Enable memory map CRC check.	0x0	R/W
0	ROM_CRC_ERR_EN	Enable ROM CRC check.	0x1	R/W

Address: 0x22, Reset: 0x00, Name: DIGITAL\_DIAG\_ERR

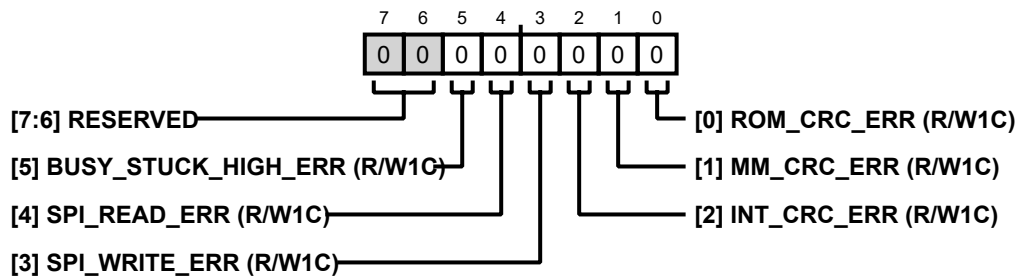

Table 65. Bit Descriptions for DIGITAL\_DIAG\_ERR

Bits	Bit Name	Description	Reset	Access
[7:6]	RESERVED	Reserved.	0x0	R
5	BUSY_STUCK_HIGH_ERR	Busy stuck high error. Busy line has been at high logic level for longer than 4 $\mu$ s.	0x0	R/W1C
4	SPI_READ_ERR	SPI invalid read address.	0x0	R/W1C
3	SPI_WRITE_ERR	SPI invalid write address.	0x0	R/W1C
2	INT_CRC_ERR	Interface CRC error.	0x0	R/W1C
1	MM_CRC_ERR	Memory map CRC error.	0x0	R/W1C
0	ROM_CRC_ERR	ROM CRC error.	0x0	R/W1C

Address: 0x23, Reset: 0x00, Name: OPEN\_DETECT\_ENABLE

## REGISTER DETAILS

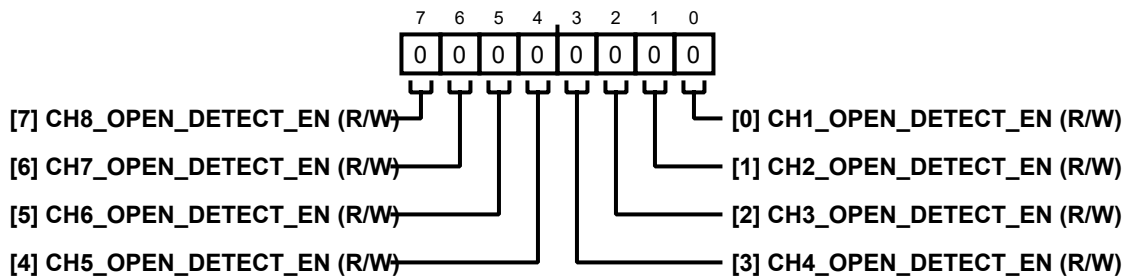

Table 66. Bit Descriptions for OPEN\_DETECT\_ENABLE

Bits	Bit Name	Description	Reset	Access
7	CH8_OPEN_DETECT_EN	In automatic mode, enables analog input open detection for Channel 8. In manual mode, sets the PGA common mode to high.	0x0	R/W
6	CH7_OPEN_DETECT_EN	In automatic mode, enables analog input open detection for Channel 7. In manual mode, sets the PGA common mode to high.	0x0	R/W
5	CH6_OPEN_DETECT_EN	In automatic mode, enables analog input open detection for Channel 6. In manual mode, sets the PGA common mode to high.	0x0	R/W
4	CH5_OPEN_DETECT_EN	In automatic mode, enables analog input open detection for Channel 5. In manual mode, sets the PGA common mode to high.	0x0	R/W
3	CH4_OPEN_DETECT_EN	In automatic mode, enables analog input open detection for Channel 4. In manual mode, sets the PGA common mode to high.	0x0	R/W
2	CH3_OPEN_DETECT_EN	In automatic mode, enables analog input open detection for Channel 3. In manual mode, sets the PGA common mode to high.	0x0	R/W
1	CH2_OPEN_DETECT_EN	In automatic mode, enables analog input open detection for Channel 2. In manual mode, sets the PGA common mode to high.	0x0	R/W
0	CH1_OPEN_DETECT_EN	In automatic mode, enables analog input open detection for Channel 1. In manual mode, sets the PGA common mode to high.	0x0	R/W

Address: 0x24, Reset: 0x00, Name: OPEN\_DETECTED

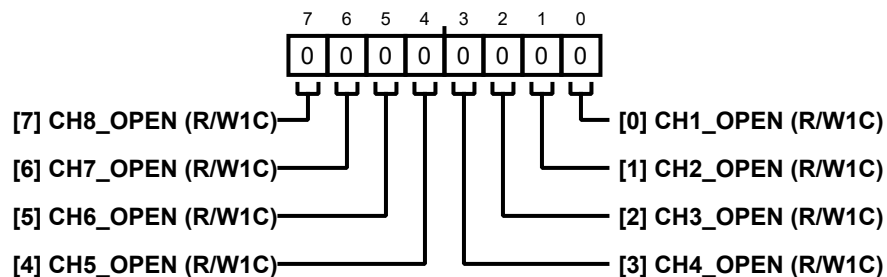

Table 67. Bit Descriptions for OPEN\_DETECTED

Bits	Bit Name	Description	Reset	Access
7	CH8_OPEN	Analog Input 8 open detected.	0x0	R/W1C
6	CH7_OPEN	Analog Input 7 open detected.	0x0	R/W1C
5	CH6_OPEN	Analog Input 6 open detected.	0x0	R/W1C
4	CH5_OPEN	Analog Input 5 open detected.	0x0	R/W1C
3	CH4_OPEN	Analog Input 4 open detected.	0x0	R/W1C
2	CH3_OPEN	Analog Input 3 open detected.	0x0	R/W1C
1	CH2_OPEN	Analog Input 2 open detected.	0x0	R/W1C
0	CH1_OPEN	Analog Input 1 open detected.	0x0	R/W1C

## REGISTER DETAILS

Address: 0x28, Reset: 0x00, Name: DIAGNOSTIC\_MUX\_CH1\_2

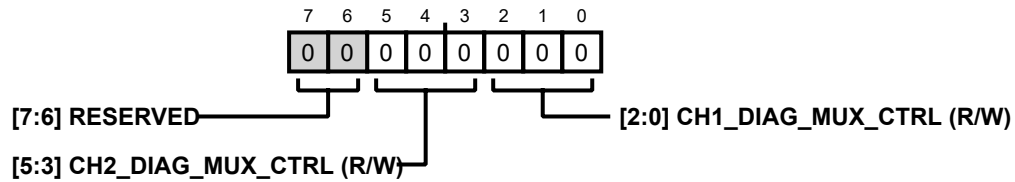

Table 68. Bit Descriptions for DIAGNOSTIC\_MUX\_CH1\_2

Bits	Bit Name	Description	Reset	Access
[7:6]	RESERVED	Reserved.	0x0	R
[5:3]	CH2_DIAG_MUX_CTRL	Channel 2 diagnostic mux control. Select $\pm 10$ V range. 000: Analog input pin. 001: Die temperature. 010: 2.5 V Reference. 011: ALDO 1.8 V. 100: ALDO 1.8 V. 101: $V_{DRIVE-}$ . 110: AGND. 111: $AV_{CC}$ .	0x0	R/W
[2:0]	CH1_DIAG_MUX_CTRL	Channel 1 diagnostic mux control. Select $\pm 10$ V range. 000: Analog input pin. 001: Die temperature. 010: 2.5 V Reference. 011: ALDO 1.8 V. 100: DLDO 1.8 V. 101: $V_{DRIVE-}$ . 110: AGND. 111: $AV_{CC}$ .	0x0	R/W

Address: 0x29, Reset: 0x00, Name: DIAGNOSTIC\_MUX\_CH3\_4

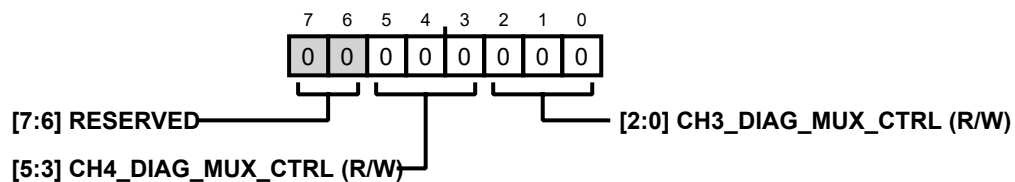

Table 69. Bit Descriptions for DIAGNOSTIC\_MUX\_CH3\_4

Bits	Bit Name	Description	Reset	Access
[7:6]	RESERVED	Reserved.	0x0	R
[5:3]	CH4_DIAG_MUX_CTRL	Channel 4 diagnostic mux control. Select $\pm 10$ V range. 000: Analog input pin. 001: Die temperature. 010: 2.5 V Reference. 011: ALDO 1.8 V. 100: ALDO 1.8 V. 101: $V_{DRIVE-}$ . 110: AGND.	0x0	R/W

## REGISTER DETAILS

Table 69. Bit Descriptions for DIAGNOSTIC\_MUX\_CH3\_4 (Continued)

Bits	Bit Name	Description	Reset	Access
[2:0]	CH3_DIAG_MUX_CTRL	111: AV <sub>CC</sub> . Channel 3 diagnostic mux control. Select ±10 V range. 000: Analog input pin. 001: Die temperature. 010: 2.5 V Reference. 011: ALDO 1.8 V. 100: DLDO 1.8 V. 101: V <sub>DRIVE-</sub> . 110: AGND. 111: AV <sub>CC</sub> .	0x0	R/W

Address: 0x2A, Reset: 0x00, Name: DIAGNOSTIC\_MUX\_CH5\_6

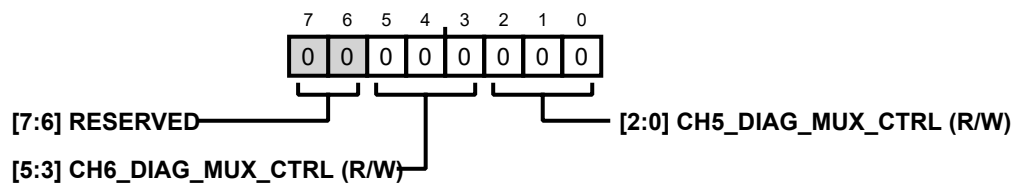
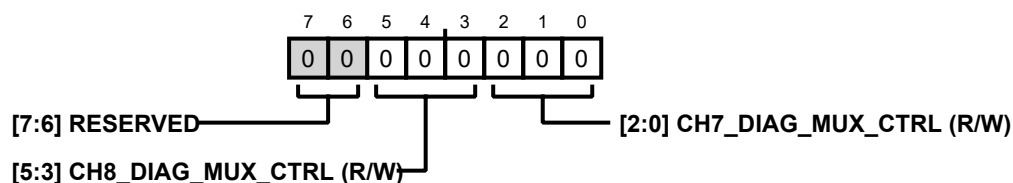

Table 70. Bit Descriptions for DIAGNOSTIC\_MUX\_CH5\_6

Bits	Bit Name	Description	Reset	Access
[7:6]	RESERVED	Reserved.	0x0	R
[5:3]	CH6_DIAG_MUX_CTRL	Channel 6 diagnostic mux control. Select ±10 V range. 000: Analog input pin. 001: Die temperature. 010: 2.5 V Reference. 011: ALDO 1.8 V. 100: ALDO 1.8 V. 101: V <sub>DRIVE-</sub> . 110: AGND. 111: AV <sub>CC</sub> .	0x0	R/W
[2:0]	CH5_DIAG_MUX_CTRL	Channel 5 diagnostic mux control. Select ±10 V range. 000: Analog input pin. 001: Die temperature. 010: 2.5 V Reference. 011: ALDO 1.8 V. 100: DLDO 1.8 V. 101: V <sub>DRIVE-</sub> . 110: AGND. 111: AV <sub>CC</sub> .	0x0	R/W

Address: 0x2B, Reset: 0x00, Name: DIAGNOSTIC\_MUX\_CH7\_8



## REGISTER DETAILS

Table 71. Bit Descriptions for DIAGNOSTIC\_MUX\_CH7\_8

Bits	Bit Name	Description	Reset	Access
[7:6]	RESERVED	Reserved.	0x0	R
[5:3]	CH8_DIAG_MUX_CTRL	Channel 8 diagnostic mux control. Select $\pm 10$ V range. 000: Analog input pin. 001: Die temperature. 010: 2.5 V Reference. 011: ALDO 1.8 V. 100: ALDO 1.8 V. 101: $V_{DRIVE-}$ . 110: AGND. 111: $AV_{CC}$ .	0x0	R/W
[2:0]	CH7_DIAG_MUX_CTRL	Channel 7 diagnostic mux control. Select $\pm 10$ V range. 000: Analog input pin. 001: Die temperature. 010: 2.5 V Reference. 011: ALDO 1.8 V. 100: DLDO 1.8 V. 101: $V_{DRIVE-}$ . 110: AGND. 111: $AV_{CC}$ .	0x0	R/W

Address: 0x2C, Reset: 0x00, Name: OPEN\_DETECT\_QUEUE

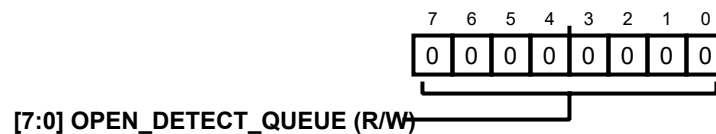

Table 72. Bit Descriptions for OPEN\_DETECT\_QUEUE

Bits	Bit Name	Description	Reset	Access
[7:0]	OPEN_DETECT_QUEUE	Open Detect Queue. When set to 1, open detect is configured in manual mode. When set to >1, open detect operates in automatic mode and the value set in this register specifies the number of conversions when there is no change in output code before the PGA common mode is switched.	0x0	R/W

Address: 0x2D, Reset: 0x00, Name: FS\_CLK\_COUNTER

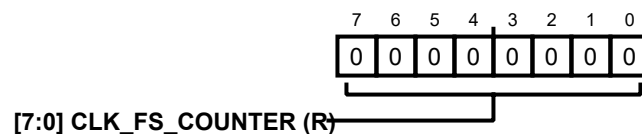

Table 73. Bit Descriptions for FS\_CLK\_COUNTER

Bits	Bit Name	Description	Reset	Access
[7:0]	CLK_FS_COUNTER	A counter that is incremented at a frequency of 16 Meg/64. Reading this register verifies the operation and frequency of the FS_CLOCK.	0x0	R

Address: 0x2E, Reset: 0x00, Name: OS\_CLK\_COUNTER

REGISTER DETAILS

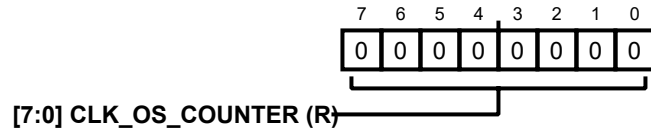

Table 74. Bit Descriptions for OS\_CLK\_COUNTER

Bits	Bit Name	Description	Reset	Access
[7:0]	CLK_OS_COUNTER	A counter that is incremented at a frequency of 12.5 Meg/64. Reading this register verifies the operation and frequency of the oversampling clock.	0x0	R

Address: 0x2F, Reset: 0x23, Name: ID

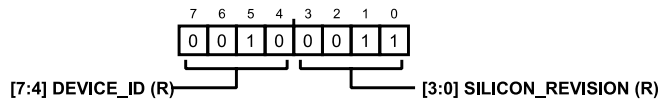
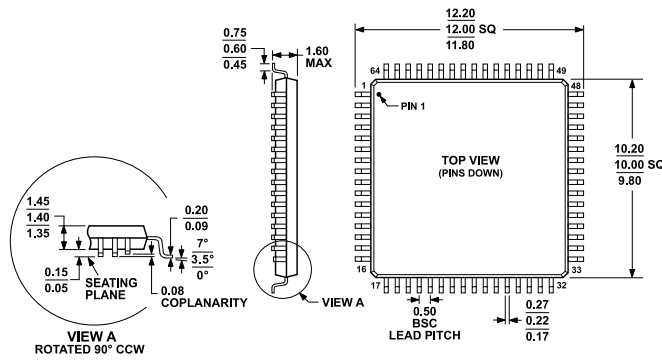

Table 75. Bit Descriptions for ID

Bits	Bit Name	Description	Reset	Access
[7:4]	DEVICE_ID	Generic. 0000: reserved. 0010: AD7606C-16 generic.	0x2	R
[3:0]	SILICON_REVISION	Silicon revision.	0x3	R

OUTLINE DIMENSIONS



COMPLIANT TO JEDEC STANDARDS MS-026-BCD

6817106-A

Figure 127. 64-Lead Low Profile Quad Flat Package [LQFP] (ST-64-2)  
Dimensions shown in millimeters

ORDERING GUIDE

Model <sup>1</sup>	Temperature Range	Package Description	Package Option
AD7606C-16BSTZ	-40°C to +125°C	64-Lead Low Profile Quad Flat Package [LQFP]	ST-64-2
AD7606C-16BSTZ-RL	-40°C to +125°C	64-Lead Low Profile Quad Flat Package [LQFP]	ST-64-2

<sup>1</sup> Z = RoHS Compliant Part.

EVALUATION BOARDS

Model <sup>1</sup>	Description
EVAL-AD7606C16FMCZ	Evaluation Board

<sup>1</sup> Z = RoHS Compliant Part.